

DAIRY PLANT DESIGN AND LAYOUT



Sunil M. Patel

A. G. Bhadania

Dairy Plant Design & Layout

Course Developers

Sunil M. Patel & A.G. Bhadania

DEPARTMENT OF DAIRY ENGINEERING
AAU, ANAND

EDITOR



AGRIMOON.COM

All About Agriculture...

Course Outline 3 (2+0+2)

Module 1. Introduction of Dairy Plant Design and Layout

Lesson 1.Types of Dairies and Perishable nature of milk

Lesson 2.Importance of Dairy Plant Design

Lesson 3.Milk Procurement

Lesson 4.Milk Reception

Lesson 5.Classification of Dairy Plants

Module 2. Location and Site Selection for Dairy Plants

Lesson6. Location of Dairy Plant and Types of Locations

Lesson 7.Location of Fluid Milk Plant and Milk Product Plant

Lesson 8.Site Selection

Lesson 9. Location of Milk Product Plant

Module 3. Planning and principles of dairy plant layout

Lesson 10.Importance of planning and principles of dairy plant design

Lesson 11. Dairy building planning

Lesson 12.Preparation of process schedule

Lesson 13.**Space requirement for dairy plant**

Lesson 14.Estimation of service requirements including peak load consideration

Module 4. Design aspects of dairy plant

Lesson 15.General points of consideration for designing dairy plant

Lesson 16.Different types of layouts

Lesson 17. Single or multilevel design

Lesson 18.Service accommodation

Lesson 19. Arrangement of different sections

Lesson 20. Service pipe-line layout

Lesson 21.Equipment layout

Lesson 22. Layout of offices and workshops

Lesson 23. Material handling

Lesson 24. Preparation of detail layout with model planning

Lesson 25. Common Problems

Module 5. Building construction materials and type of building construction

Lesson 26. Choice of building construction materials - Brick, sand, cement, lime etc.

Lesson 27. Building materials – stones, wood, metal, glass etc.

Lesson 28. General requirement of dairy floors and floors for different sections

Lesson 29. Structural Aspects of Foundations, Roofs, Ceilings, Walls, Doors and windows

Lesson 30. Drain and drain layout for small and large dairies

Lesson 31. Ventilation, Illumination and fly control

Lesson 32. Paints, coatings and mold prevention

Lesson 1.

Types of Dairies and Perishable nature of milk

1.1 Introduction

Since India is the leading country in milk production in the world at a fast rate, it has been lead to a need of very scientific layout and planning for the dairies being set up by the dairy designers, engineers and architects. In some organized sectors, milk collection and chilling of milk is done, before it is transported for processing at dairy factory. The dairy technology commences with processing of milk at dairy plant for market milk and various dairy products. The dairy plant layout and design means designing a layout plan for dairy plant. i.e layout of various sections in dairy building, equipment layout, laying of dairy machines in each section for economical and efficient movement of men and material in the plant.

Milk and milk products, however, impose certain requirements which do not occur elsewhere in food or other industries. These special requirements affect the structure and the layout of the building, the provision and distribution of services and the choice of site. The products of dairy industry – milk for liquid consumption, yoghurt, curd, cream, butter, ghee and similar products, cheese, milk powder and so on- are foods which play a fundamental part in human nutrition. Materials and methods used in building must be such as to give the longest practical life with the minimum of maintenance, in spite of working conditions which are often relatively severe from both the mechanical and chemical point of view. It should also be seen that most of the repairs, alterations or extensions could be done without stopping the production. These characteristics demand closest attention during planning.

There is a need for highest standard of hygiene. Milk is most suitable medium for the growth of microorganism, therefore every possible measure should be taken to reduce the possibility of contamination, especially after processing. A good layout design and use of proper materials and techniques make great contribution towards hygiene. The dairy layout needs careful thought and planning keeping in view manufacture of the products and their commercial aspects.

1.3 Perishable nature of milk

Milk by its nature is perishable. The following three factors contribute to its being perishable:

- (i) Contamination with bacteria due to widely dispersed and unhygienic collection methods
- (ii) Warm temperatures of tropical climate
- (iii) Prolonged time before cooling or processing

In practice, none of these factors can be eliminated completely, so if any one is accentuated, the life of milk will decrease. Therefore, every effort must be made to minimise these factors on the farm, during collection at milk plant and during distribution to consumers. At the farm, the aim must be to cool milk as soon as possible after milking. Ideally, the milk should be chilled to 4°C within two hours after milking. If for any reason this can not be done at farm, quick transport of milk to the plant is essential. If milk can be stored conveniently at the farm or local collecting depot at low temperature, the organization of transport to milk processing plant is simplified to greater extent by transporting bulk quantity in insulated tankers. The type, size and number of vehicles

necessary are, therefore determined not only by the usual factors such as distance or nature of roads but also by the condition of milk production.

When the milk is drawn from the udder of the milch animals (cows, buffaloes, goat, sheep, etc.), the quality of milk is almost sterile. The milk has its own anti-microbial system present which is active till 2 to 3 hours of milking. The components in milk such as lacto-peroxidase system, immunoglobulins, lactoferrin, etc. have the anti-microbial effect. The perishable nature of milk comes into picture with the contamination from air, human, and milking utensils. The temperature of milk during milking is equal to body temperature i.e., 37°C. The milk being very rich in nutrients such as carbohydrates, fats, proteins, minerals, vitamins and water, becomes good media for the growth of micro-organisms. So the milk should be immediately sent to the dairies within 2 or 3 hours of milking, before it gets sour. If the dairy is very far away from the milk collection area, it should be chilled to below 10°C in the bulk milk coolers at the farm level (village co-operatives and/or chilling centres) so that the microbial activity is inactivated.

1.2 Types of Dairies:

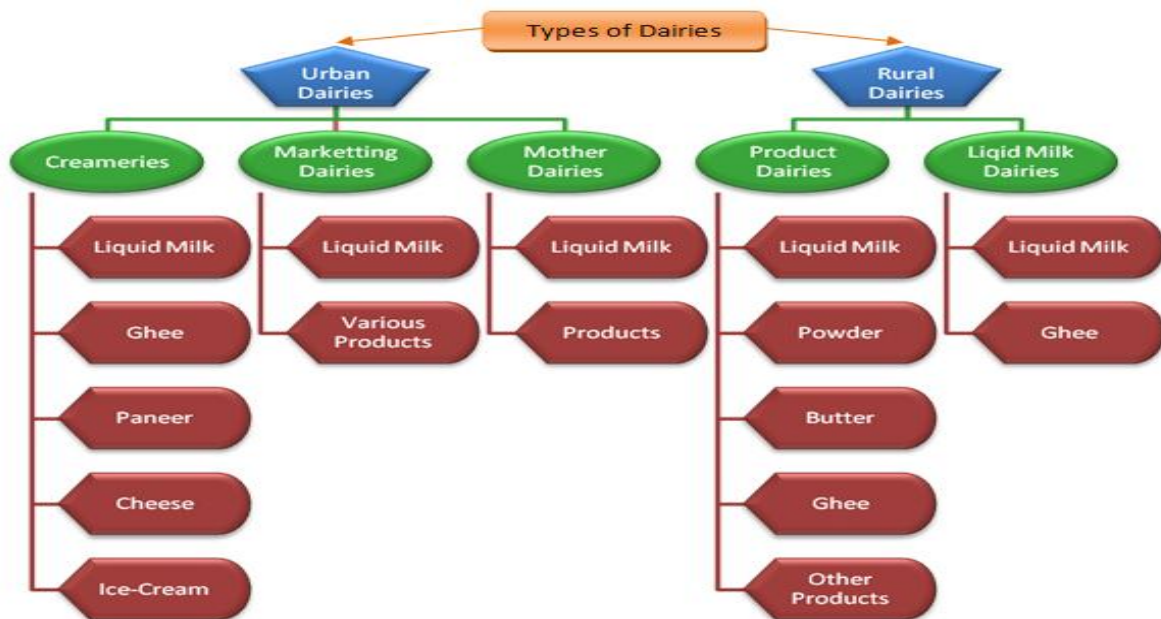

Fig. 1.1 Types of dairies



Lesson 2.

Importance of Dairy Plant Design

2.1 Introduction:

Dairy Plant design, involves the estimation of capacity, process scheduling and proper layout so as to achieve the objective of handling milk at the least cost and greatest safety. However, the dairy industry and the plant design has to meet certain special requirements and need to be focused on these. The following are the few aspects that make the dairy industry as a unique one.

Special Characteristics of Dairy Industry:

1. Perishable nature of milk: Milk is one of the most perishable of the agricultural commodities, and has only few hours of shelf life unless it is chilled and processed. Hence, the TIME factor is the most important aspect to be involved in the dairy plant design and lay out
2. Milk is an essential commodity. It provides nutrition especially to children and aged. Hence the dairy industry has a high profile in the society, and its functioning is very essential to the well being of the society.
3. Seasonal nature: The dairy industry has to deal with availability of raw milk fluctuations depending on the season. It is available in certain months, called Flush season when most of the calving and green fodder is available. During summer months, when milk availability dips due to most of the animals coming to end of their lactation period. Hence, OVER CAPACITY is the factor to be considered in plant design and layout, as the plant is to meet the peak procurement of the flush season, while in the remaining months it is having excess capacity. Also flexibility of the plant design and layout has to be considered.
4. Milk is a food item, which has to be consumed, especially by children and old people. Hence, PLANT HYGIENE is the important factor in plant layout and design.
5. Effluent disposal of dairy plant is essential as the volume and BOD value of the dairy effluent is high. Sufficient planning is required to handle this high volume of effluent to be handled by Effluent Treatment Plant (ETP).
6. Dairy Industry has to meet the various legal aspects and mandatory requirements. It has to meet the Industrial act, Labor act, Boiler act, Pollution control act. It also has to meet the HACCP and FSSAI guidelines.

2.2 Importance and economics of plant design:

The products of dairy industry i.e., liquid milk, yoghurt, curds/dahi, cream, butter, ghee, ice-creams, cheese, milk powders, shrikhand, traditional Indian dairy products etc. are foods which are very important for human nutrition. Therefore, it is very necessary that the milk and milk products should be available to everyone at the lowest possible rate. Also the profit margin that the dairy entrepreneur expects is limited. Therefore, the capital outlay of the building and plant should be economical. Planning must be done wisely to make best use of the labor employed and to keep operating costs to a minimum. Materials and method used in building must be such as to give the longest practical life with the minimum maintenance, in spite of working conditions which are often relatively severe from both mechanical and chemical points of view. It should also be without stopping the production.

To extend the shelf-life some techniques like quick heating, quick cooling, acidification etc. are applied and also various advanced packaging techniques are used. The Dairy Technology starts with milk processing till the final products such as market milk and conversion into various products. So the subject Dairy Plant Design and Layout is the designing of layout plan for a dairy plant, i.e., layout for different sections in the dairy building, equipment layout, laying of dairy machines in such a manner that it allows efficient and economical movement of men and material in the plant in each section. The subject contains several applications of fundamental topics, such as locations site selection, building materials, specific requirements of each section including service sections.

2.3 Legal and commercial aspects of plant design:

Care should be taken to provide adequate natural and artificial lighting. Every possible effort should be made to ensure that the building and the site will be pleasant to look at. The architect can provide a good landscape and an attractive outlook. The welfare of the employees must be kept in view. Canteen facilities are essential to meet the requirement of Labor act. Ultimately, the dairy plant layout requires careful thought and planning keeping in view manufacture of the products and their commercial aspects. A sound layout engineering contains allowance for increase in capacity by arranging the production departments and selecting the type of building that can be expanded at low cost. It should be easy to increase the output capacity which may be required in the future. A floor arrangement that contributes to the low cost production planning and control are achieved in good plant layout. Material control and steady amount of production capacity can be easily attained with minimum idleness of machinery and man. Finally leading to the delivery of products in short notices can be achieved.

Safety and good working conditions are very necessary in a proper plant layout. Minimized hazards at the working stations, in material handling, storage, maintenance operations and so on are features of good plant layout. Minimum man hour losses, reduction in capital equipment and material losses incorporate improved working conditions. Increased employee moral tends to reduce production costs and helps develop a stable operating force.

In planning the building, several important factors have to be studied in detail before the plant could be developed to the stage of construction. The size of the building and the floor space to be provided depend upon the processes and choice of appropriate steps, numbers and associated equipment to be accommodated and the most important factor of rearrangement of facilities in the initially built building and provision for expansion of the building without costly modifications. A high degree of sanitation is necessary to ensure protection from contamination, odours, chemicals, organisms, etc. This includes the interior and exterior of the building and sanitary conditions of the environment. Simple pleasing design with high utility value without undue importance to architectural factors is necessary.

Civil Engineering aspects of plant design : The type and methods of use of civil construction is evolving day by day. New materials are being developed to meet specific requirements of industries. The planning of civil construction is very much related now to meet the requirements of HACCP and FSSAI acts, which are more stringent in nature. Structural modules of RCC Columns and beams gives good flexibility in the location of the equipment and layout of service lines. The height of the ceiling is another important factor. Plain smooth surface of the underside of the ceiling with embedded fixtures for lighting and pipe supports, etc. , into the ceiling is best.

2.4 Advantages of a good plant layout

1. A good layout reduces
 - a. the effort in normal material handling of a worker
 - b. cost of handling by direct labor and hence increased productivity per man hour and
 - c. indirect manufacturing cost by decreasing spoilage under difficult handling situation
2. It uses only essential space required and eliminate congestion and accident, permits flexibility for methods improvement and future expansion besides making supervision easier.
3. It also facilitates scheduling and despatching operation.



Lesson 3.

Milk Procurement

3.1 Introduction:

The wide range of milk procurement methods and handling has an affect on the plant design and layout. The method of milk procurement is also changing over the years. The recent trend of Bulk Milk Cooling at village clusters is altogether eliminating the procurement of milk by cans at the Dairy plants.

Lack of attention during procurement, processing and storage leads to decrease in the milk shelf-life. Quick chilling of milk should be done during the procurement if the dairy is far away from the Dairy Processing Plant and such milk is to be transported in bulk in insulated tankers to the dairies. In India, milk production is carried out in rural areas from where it is transported to milk processing plant. Thereafter distribution to consumers is done through depots and/or milk parlours.

3.2 Milk procurement:

In most of the countries, milk production is carried out in rural areas from where it is transported to milk processing plant. Under Indian conditions, milk has to be regularly collected and transported twice a day, morning and evening. The usual methods of milk collection and reception at dairy plant are:

(i) Milk procurement through individual producers: In this milk is brought to the dairy plant by the individual producers in their own vessels of any type. This is possible for those producers who are located nearby milk collection centre.

(ii) Milk collected through co-operative organizations: Here, co-operative societies form an organization which is responsible for uninterrupted supply of milk to the dairy plant. Supply of milk can also be affected by single co-operative society formed by milk producers. This is beneficial to the producers as there is no middle man to share profit.

(iii) Milk procured through contractors: In this method the contractor supplying milk to the dairy plant collects the milk from producers at a cheaper rate and transports the milk to the dairy. Therefore, there is less return to the milk producers, as milk contractor will keep his share in the profit.

(iv) Milk reception from milk collection cum chilling centres: This method is generally possible and is prevalent in organized sectors, and dairy operations in India.

Milk is collected at various milk collection centres from nearby villages in 40 litre cans usually belonging to the organization. The milk is weighed, tested for fat content and kept ready to be dispatched to the milk chilling centre. From collection centre milk is picked up in an open truck and brought to milk chilling centre or dairy plant, where milk cans are emptied, washed through can washer and sent back to milk collection centres for next day collection of milk.

3.3 Three tier structure of 'Anand Pattern'

The Anand pattern for collection of milk, processing and marketing of milk and milk product is very popular for co-operative structure in Gujarat, and few other states. Fig. 3.1 shows three tier system of 'Anand Pattern'.

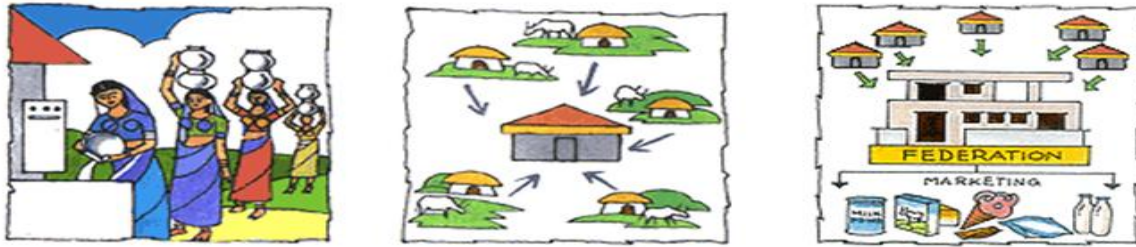

(i) The village level society, (ii) The district union, (iii) The state federation

Fig. 3.1 Three tier structure of 'Anand Pattern'

i) The Village Society

An Anand Pattern village dairy cooperative society (DCS) is formed by milk producers. Any milk producer can become a DCS member by buying a share and committing to sell milk only to the society. Each DCS has a milk collection centre where members supply milk every day. Each member's milk is tested for quality with payments based on the percentage of fat and SNF. At the end of each year, a portion of the DCS profits is used to pay each member a patronage bonus based on the quantity of milk poured.

ii) The District Union

A District Cooperative Milk Producers' Union is owned by dairy cooperative societies. The Union buys all the societies' milk, then processes and markets fluid milk and products. Most Unions also provide a range of inputs and services to DCSs and their members: feed, veterinary care, artificial insemination to sustain the growth of milk production and the cooperatives' business. Union staff train and provide consulting services to support DCS leaders and staff.

iii) The State Federation

The cooperative milk producers' unions in a state form a State Federation which is responsible for marketing the fluid milk and products of member unions. Some federations also manufacture feed and support other union activities.

The transportation of milk to milk collection centre by various methods has an important bearing on the quality and time constraints placed on the milk procurement.

Table. 3.1. Various modes of transportation of milk to collection centre

Mode	Optimum load (kg)	Optimum distance (km)
Head or shoulder load	5 to 10	2 to 5
Animal (Ponies, Horses, Donkeys)	80	6 to 10
Bullock cart	300 to 400	10 to 12
Tongas	200 to 300	12
Bicycles	40 or more	15
Cycle rickshaw	100 to 150	10
Boat (for crossing rivers)	50 to 200	2 to 8



Lesson 4. Milk Reception

4.1 Introduction:

The objective of handling the milk as quickly as possible continues even at the milk reception, as the milk is still vulnerable to the spoilage, till it is chilled and taken into milk storage tank, and processed. The crucial stage of milk reception also involves the responsibility of checking the quantity, quality for acceptance, and the time management of handling many vehicles.

As mentioned earlier the timing is an important parameter while deciding about the mode of reception and transport. The load, distance to be covered and relative merits are given below in Table 4.1 and 4.2.

Table 4.1 Various modes of transportation of milk to the Dairy Plant:

Mode	Optimum load (kg)	Optimum distance (km)
Auto-rickshaws	250 to 500	15
Motor truck	3 tonnes	15
Road tanker	5 tonnes	100 or more
Rail tanker	5 tonnes	1000 or more

Table 4.2 Mode of transport and their corresponding advantage.

Mode of transport	Advantage
Road	<p>Loading and unloading conveniently done at godowns of sellers and buyers.</p> <p>Cheaper than rail over short distances.</p> <p>Less time consuming.</p>
Rail	<p>Cheaper than road over long distances.</p> <p>Large quantity of milk can be handled at a time.</p>
Can	Small quantity of milk can be handled.
Tanker	<p>Faster mode of transport.</p> <p>Low cost.</p> <p>Better temperature control.</p> <p>Less risk of contamination.</p> <p>Time and labour saving.</p> <p>Low investment in cans.</p> <p>Saving in detergents.</p>

4.2 Reception at the Dock:

The milk as soon as it is received at plant, is weighed, dumped into the dump tank (weigh tank) and has to be chilled before it is stored for processing. This has to be done in quick succession through equipment well planned and installed at milk reception dock and receiving room.

The reception of milk at the Raw Milk Reception Dock (RMRD) is done in three ways i.e., in cans, in milk tankers and combination of both. The type, size and number of vehicles can be determined by factors such as distance or nature of the roads and condition of milk production. In the chilling centres or BMCs, the milk is received only in cans (may be 40 lit or 20 lit capacity cans). In case of Marketing Dairies, the milk is received only in milk tankers where as in feeder dairies the milk is received in both cans as well as in tankers. The trend of establishing BMCs at village clusters has changed the mode of reception and monitoring of quality and quantity at Dairies.

There are some products that depend on the type of milk like cow and buffalo milk. Therefore, the reception dock may consists of two separate systems for cow milk reception and buffalo milk reception at chilling centres as well as in feeder dairy plants. In most of the dairy plants however, the milk is received as mixed milk.

If the milk is received in bulk through tankers, the arrangement has to be made for quick transfer of milk through milk pumps installed at milk reception dock to milk storage tanks. The milk received in the evening may be chilled and the stored for processing next day. All this will need careful planning of layout of equipment at milk reception dock and milk receiving room. Roads leading to milk reception dock and dispatch dock have to be planned in such a manner so as to avoid traffic congestion inside the factory or road blockage.

4.2.1 Essential features of RMRD :

The RMRD dock should be of height suitable (usually 1.5 m) to receive milk from whatever mode of transport without spillage during unloading. For Milk tankers, the Tanker Bay must be spacious, suitable for washing and unloading at least two tankers at a time. The pump should be of 20,000 l/h capacity to unload faster. If the milk quantity is to be measured by weigh bridge, it should be properly calibrated and inspected periodically by local weights and measure authorities. If the quantity is to be measured by dip stick alone, then the tanker bay must be suitably leveled to avoid errors in measurement.

4.3 The important equipments for reception of milk processing plant on the RMRD are:

- Can conveyor: It should be of suitable type and length to transport easily the cans from the edge of the dock to the can tilting bar at the dump tank. The rate of reception and capacity of the dairy plant are also important in deciding about the type of can conveyor, like whether a Roller type or motorized chain conveyor.
- Milk weighing tank: The equipment involves a weigh bowl and dump tank. The capacity of weigh bowl should be able to weigh at least 4 cans, which may be an average quantity received from each village. Weigh bowl may be linked to indicate on a dial type of scale or through load cells in digital form of indication and recording
- Weighing scale: The weigh scale must at least be of 300 kg, so that the normal range of quantity of milk received from village is between 40 to 60% of the scale. The trend of digital indication through load cells are catching up, which has the advantage of recording as well as print out simultaneously, for easy monitoring and documentation. This is improving the confidence level between milk collection centres and dairy that is receiving the milk.
- Dump tank with cover: The capacity of Dump tank is at least twice the capacity of weigh bowl, so that while the milk quantity of one village is being weighed, the other quantity is being pumped out from dump tank to the

milk chiller. Recent trend is to link the level sensors and milk pump to get started and stopped when the milk level is high and low respectively.

- Drip saver: The drip saver must be of SS and should have drain leading to the dump tank, or to a separate can, which is emptied to dump tank from time to time.

- Can washer: The capacity of can washer should meet the rate of reception and dumping. Mostly Straight through can washers are chosen, and the empty can conveyor leads the washed cans to the dock or to the edge of RMRD to be loaded into vehicles.

- Milk pump: The milk pump used for pumping milk from dump tank to the plate chiller through in-line filter, should match the rate of reception. It is installed at a level lower than the dump tank and has flow control valve at the discharge side, The filter is sometimes located on the suction side to avoid threads, tags, etc connected with cans getting jammed into the pump impeller. The pump, in recent times is linked with control system to operate as per the level in the dump tank, to prevent overflow of dump tank or pump running dry by oversight of the operator.

- Plate chiller: The Plate chiller is usually of PHE type and used for chilling milk to 4°C. The Plate chiller is sized to meet the reception rate, and may sometimes be two in number, one each to receive milk by cans or road tankers. If the chiller is to receive milk from road tankers, the capacity is usually much larger, to meet the higher rate of reception to unload tanker rapidly.

- Raw milk silo: This is a vertical storage tank or a battery of storage tanks, that are specifically identified to store raw milk only. The silos can be located outside the processing hall, but connected to the hall through an opening called 'Alcove'. The operation of opening, closing of inlet and outlet valves, measuring the temperature, controlling the agitator etc are done from inside of the processing hall itself, though the silo is located outside. The tank overflow line will be positioned to inside of hall, so that the operator can know if the tank is full and overflowing.

- Milk testing laboratory: This is a preliminary testing laboratory, to perform so called Platform tests, like COB, acidity, turbidity, etc.

The Reception dock is essentially separated from the processing hall by partition doors, or walls, with fly proof devices like air curtains, or mesh doors. The trend now is to provide even the RMRD dock with provisions to prevent entry of flies and insects.

The crucial design calculations of the rate of dumping is illustrated by following example :

1. Milk to be received by Dairy Plant: 10,000 LPD
2. Milk to be received by AM and PM in the ratio of: 60:40
3. Milk to be received in the AM: $10,000 \times 0.60 = 6,000$ lts
4. Milk to be received in two hours
5. Milk reception per hour: $6,000 / 2 = 3000$ LPH

Hence the design of all the reception dock equipment will be to meet the above requirement of 3,000 LPH.

Lesson 5

Classification of Dairy Plants

5.1 Introduction:

The design and layout of the dairy plant depend much on the quantity of milk handled and the type of the product made. Some may need refrigerated condition for the distribution of the product, while others may not need such requirement. Some of the products may not need a daily delivery and need to be transported once a week or so. There is a wide variation in the size and type of dairy plants. Fig. 5.1 and Fig 5.2 shows broad classification of milk plants.



Fig. 5.1 Classification of dairy plants as per type of organization and capacities

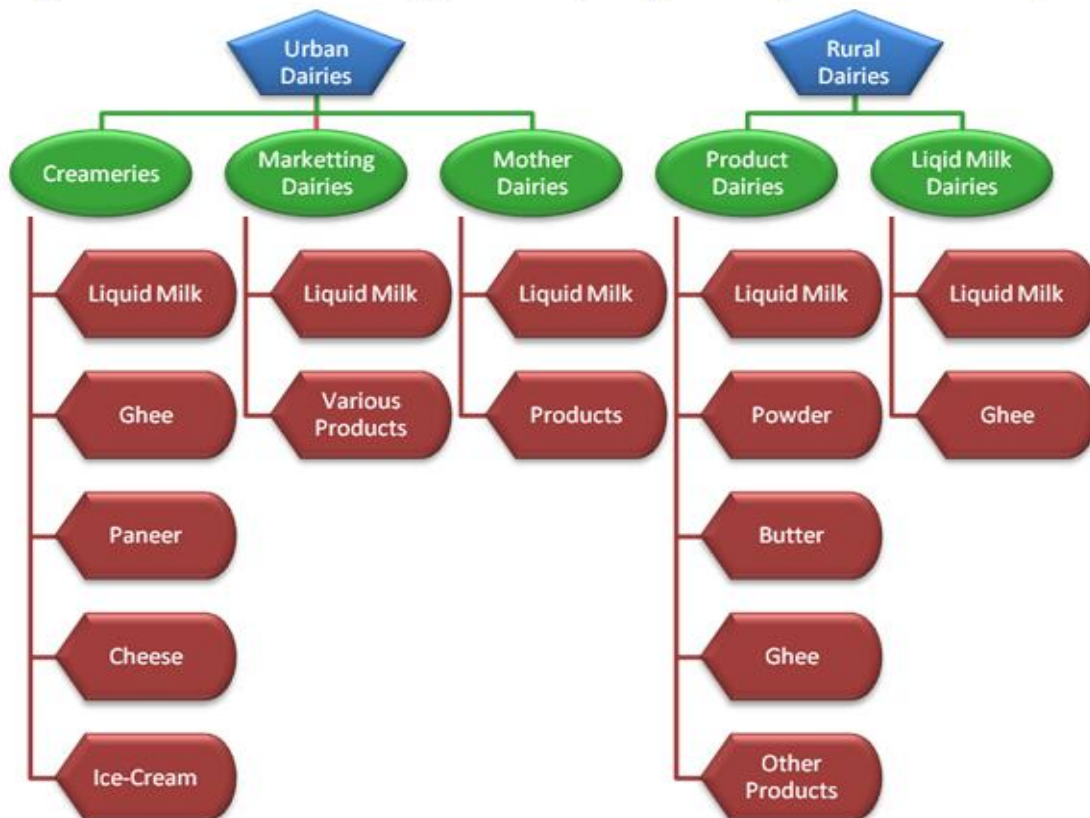

Fig 5.2 Classification of the dairy plants as per the location and type of products

The milk plants can be classified broadly into two groups –

· **Liquid Milk Plant**

This type of plant should be situated/located as close as possible to the consumer area i.e., generally in or on the outskirts of a large city or town. It supplies market milk in chilled condition in small retail packs.

· **Product Milk Plant**

Here, there is the production of products like cheese, butter, ice-creams, etc. which do not require daily distribution to the consumers. So the plant should be located near the producing areas. The difference in the location areas of both plants results in the minimized transportation cost.

Milk plants can be classified based on its capacity also :

· **Small Capacity Milk Plants**

These are usually below 10,000 LPD and may need to load milk in road tankers and send to larger dairies. Very limited local sales of liquid milk could be possible, as these are essentially located in small towns.

· **Medium Capacity Milk Plants**

The capacity of the medium sized dairy plant ranges from 20,000 lit to 1,00,000 litres of milk handling per day. Layout for products like market milk, butter & ghee and cheeses can be designed. Each room should be planned separately and arranged with forward flow of product as per requirement.

· **Large Capacity Milk Plants**

Here, the plant building may have few floors having multi-product manufacture, where the reception is done at the ground floor and should have both milk treatment and tank storage on the first floor. If products like milk powder are to be manufactured, then the powder plant should placed in different building.

The classification in general may be subject to change in the capacities and there can be a certain overlap in the type and products handled. Some dairies could be handling both liquid milk as well as products, to maximize their market reach and profitability. Though there were certain restrictions in the area of operation of dairies, the same is not strictly enforced or adhered to at present.



MODULE 2 - LOCATION AND SITE SELECTION FOR DAIRY PLANTS

Lesson 6

Location of Dairy Plant and Types of Locations

6.1 Introduction:

Location and site selection for dairy plants forms the important first step in plant design and layout. It has a bearing on the profitability of the dairy and initial quality of the milk. The step is further an important one as any mistake here cannot be corrected easily. The size and operation of the plant also gets restricted if the decision is not made properly at this stage.

6.2 Selection of Location:

The problem of selecting a location for a dairy plant has been given considerable thought by many authorities. Selecting a location involves large commitments of capital, as a result it must be done with the utmost care. The problem involves selecting a region as well as specific site within that region. The most difficult part of a plant location analysis is determining the criteria by which various location alternatives can be evaluated.

As the dairy plant construction involves a very large initial capital investment, numerous considerations must be evaluated at the very beginning in the planning of a new plant. Out of these, the location and site selection requires utmost care as it forms a large single capital investment. It involves selecting a region as well as a specific site within the region, of which the most difficult part is determining the criteria by which various location alternatives can be evaluated.

Location is a strategic issue, and the decision where to locate cannot be taken lightly. It is the first decision in the implementation of a project. Upon the decision to proceed, an investment is made which is irreversible. That investment in bricks and mortar cannot physically be transferred to another location if the decision turns out to be wrong. The most favorable location is one, which attains the lowest unit cost in producing and distributing the product or service to consumers.

Traditionally, a location was selected for reasons of economic geography like,

1. Proximity to raw material source
2. Proximity to relatively cheap and abundant energy
3. Availability of relatively inexpensive manpower or specialist skills
4. Proximity or good transport links with materials suppliers and markets.

But nowadays, the location decision has become more complex with newer intervening factors like more sophisticated markets, increased competition, short supply of skills, technological change that soon outdate newly installed processes, shooting costs of land and materials, government influences, legal requirements, corporate matters and peoples' influences. In general, in selecting an area to locate a plant, following consideration should be given to the following factors

1. Availability of spacious land for immediate requirements of all buildings, roads, service facilities, garden, tree plantation for wind break etc., with provision of land for expansion at a future date
2. Accessibility and availability of raw materials
3. Accessibility of market
4. Adequacy & availability of labor
5. Adequacy of transportation facilities
6. Volume of power and fuel
7. Water supply and its quality
8. Soil conditions for heavy loading
9. Site cost
10. Elevation in location to facilitate removal of dairy effluent, suitable treatment and disposal
11. Climatic conditions, including direction of prevailing wind and probable increase in dust and smoke nuisance from the surroundings, and
12. Government laws
13. Market Potential
14. Clean environment

The two terms location and site are often confused with each other. It must be clearly understood that, the term 'location' implies to Area, Region or Territory, while 'site' is the place, within a selected location, where building is to be constructed.

6.3 Plant location

Location is primarily influenced by the nature of the product manufactured. The general location and the specific site should be selected with the aim of attaining as nearly as possible the ideal over-all economic situation for the particular enterprise, may it be a fluid milk plant or milk product dairy. The most favorable location is one that attains the lowest unit cost in producing and distributing the product or service to consumers.

6.3.1 Differences between location and site

The two terms location and site are often confused with each other. It must be clearly understood, that, the term 'Location' implies to Area Region or Territory, while site is the place, where building is to be constructed.

6.3.2 Location problem

Location problem has to be solved at two levels, first Territory or Region level and second site level. Some location factors may be applicable to both the levels. Still region level and site level are to be given specific consideration.

6.3.3 Types of Location

Three types of locations are possible for dairy plants viz. i) city location ii) suburban location and iii) country location.

6.3.3.1 City location:

When a city is planned by a town planner, all areas are marked for future buildings. The industries likely to come up are marked in area called 'Industrial area' and usually dairy plants are allotted a plot in that area only. Dairy plant in the neighborhood of other industry or factories emitting smoke, dust, offensive smell, gases, carries great risk. It is therefore essential, that the location marked for milk plant should be free from all pollution.

6.3.3.2 Suburban location:

Suburban location means suburban town or outer skirts of large city. The dairy plant located in this situation has advantages of being close to consumption area with possibility of availing all facilities such as electricity, water, waste disposal and labor etc.

6.3.3.3 Country location:

Country location means sitting dairy plant in country or milk producing area. There will be little competition from other industries and land will be cheap. The plant will not create a noise problem and it is unlikely that atmospheric pollution will cause any difficulty. There will be no traffic congestion. Milk supply routes will be short. But it will be away from the city consumption area.

For all the dairy plants in whatever region they are, there are some important points which are common and essential to be considered in determining the location. Moreover there are some problem factors applicable to both region level and site level. The former is covered in the subsequent chapters while latter is given in the Table. 6.1.

Table. 6.1 Problems related to regional location/plant site factors

Problem	Regional location Factor	Plant site factor	Comments
Water supply	Limited surface water supplied forcing dependence on uncertain underground supply or costly city water. Water is contaminated by city sewage.	Plant site lacks its own water, forces use of city water, nearby industries contaminate water supply making it necessary to install costly purification equipment	Importance of supply and cost of water depends on the process. Ample supply of low cost water will be increasingly important. Having own water supply i.e. tube wells and setting up of water treatment plant will combat the problem
Fuel costs	High freight charges on coal, fuel oil supplies	Inadequate storage space on plant site for coal, oil to insure against emergencies	With labour and raw material costs high, one cost reducing path is to reduce service bills. Locate the plant where fuel is available at reasonable cost
Electricity	State Electricity Board's electricity is available, but not adequate to meet peak load requirements		If state electricity supply is available at reasonable cost, use it and set up own generating plant to meet rest of the requirements
Sewage and waste disposal	Municipal regulations limit low cost disposal of waste	City sewage facilities are limited, require costly additions. Local ordinances restrict waste disposal. Limited space forces expensive methods to eliminate waste.	Not a major item for many plants, but does affect costs, community relations on the right plant site, disposal of solid wastes can be turned into an asset used to fill land
High maintenance cost	Severe climate attacks paint, building materials and equipment. Shortage of trained labour means abuse of machinery, need for frequent repair	Poor soil forces continued rebuilding of foundations. Nearness to plants emitting dirt, smoke add to paint, cleaning bill	Most of companies with clean operations end up near a plant that belches smoke and dust. Make most out of plant appearances a sales and workers' morale tool by picking a clean location and cut maintenance costs while doing it
Cost of supervision	Shortage of trained supervisory personnel due to competition. Area does not appeal as a place to live	As in case of workers, plant is hard to reach, nearly living conditions are not satisfactory	Supervisors are more flexible in their views, more ambitious than plant labour and will accept inconveniences. But they expect higher pay to work in unpleasant surroundings.
Expansion	Too far from market or from suppliers or from both, to add to productions, sales and still meet competition. Labour supply limited to present operating needs	No room for convenient expansion of production on the plant site	If the company is planning to expand its operations, it is a 'must' a stop and re-examine your plant location and plant site. More money invested in present site only makes it more costly to move later, if that is desirable

Lesson 7 Location of Fluid Milk Plant and Milk Product Plant

7.1 Introduction:

The location of the fluid milk and product plant differ in more ways than one. The fluid milk plant has the requirement of disposing the milk in retail containers or packets, at refrigerated condition to consumer on day to day basis. On the contrast, milk powder factory has to dispose product at room temperature itself, and not on daily basis. The wide variation in the scale and method of disposal of the products does have a bearing on the location. For example cheese manufacturing needs cow milk. Hence the location of cheese factory should preferably be in cow milk producing area.

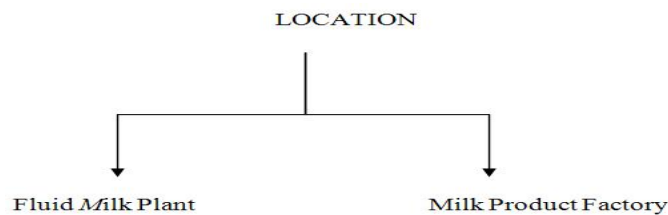

A market milk plant that handles only fluid milk should preferably be located in a city or its outskirts due to the following reasons:

1. Nowadays good transport facilities are available, that connect the country milk shed areas to the cities
2. Even after pasteurization, milk has got a lower shelf life when compared to other products, hence it should be disposed as soon as possible
3. Bulk transport of pasteurized milk can increase the chances of contamination
4. If glass bottles are used which are to be returned for re-use, location near the market will reduce the costs
5. Increased advertising value of the plant, when it is near the market

Usually space is allotted for dairy plants in the industrial areas; hence environmental aspects are to be considered as Industrial areas tend to be highly polluted. Preferably the plant should be located on a side road to a major road, because

1. Easy access to the major road
2. Pollution, noise and dust of major road avoided
3. Traffic blocks won't create a problem at the gate for incoming and outgoing vehicles

7.2 Location and site selection for dairy plants.

The problem of selecting a location for a dairy plant has been given considerable thought by many authorities. Selecting a location involves large commitments of capital, as a result it must be done with the utmost care. The

problem involves selecting a region as well as specific site within that region. The most difficult part of a plant location analysis is determining the criteria by which various location alternatives can be evaluated.

7.3 Location of Milk Products plant:

The location of milk product plant is decided based on milk product consumption, availability of milk, and other services required. It is advantageous to locate manufacturing plant close to areas where surplus milk is available after meeting the daily requirement of liquid milk. The activities of milk product manufacturing should be centralized to get advantage of economic handling of fluid milk, seasonal surplus milk and milk products with a better management control.

A few points mentioned below will help in determining the location **milk product** of plant:

(i) The plant should be located at a place where transportation facilities are available, such as railway siding or near highway. It should be noted that, suitable site would always provide easy transport of raw material to the plant and disposal of finished products.

(ii) To avoid contamination, the bulk transport of pasteurized milk should be discouraged. If pasteurized milk is to be distributed in glass bottles or small containers which are to be returned for reuse, the dairy should be situated close to consumption area. For any reason, if dairy is situated far away from consumption area, it is necessary to transport bottled milk in large quantity to local depots equipped with cold storage facilities.

(iii) Advertising value also affects the location of the plant. For instance a plant installed by the side of a heavily traveled highway naturally commands good sales.

(iv) Location of building should be such, that, all necessary services e.g. electricity, water, waste disposal are available at reasonable cost.

(v) The site must be large enough and of suitable shape to give freedom in planning the building and to allow space for future expansion.

(vi) The area should be free from atmospheric pollution.

(vii) Adequate labor must be available at site and it may be necessary to provide housing facilities to workers.

(viii) Traffic congestion around the plant should always be avoided. Larger plant will require more land for smooth control of traffic pattern.

For any entrepreneur desirous of setting up a dairy industry, it is advisable to go through the following check list on 'Location' to assess its suitability. A milk product plant can be located preferably in a village location due to the following reasons;

1. Proximity to the milk shed, reduced transportation cost for raw material
2. Increased shelf life of the product when compared to the raw material
3. Availability of cheap land and labor
4. Reduced noise and pollution

5. In many cases the volume of the final product is less than the milk used, hence reduction in transport and handling cost eg: Cheese, Butter
6. Solid products can be transported in trucks
7. Some products doesn't even require cold-storage.



Lesson 8

Site Selection

8.1 Introduction:

Once the broad location for the dairy plant is decided, within that limited area of location, a site is to be chosen depending on some factors that maximize the operational flexibility and minimize the operational cost as well as contamination. The site should also be selected keeping in view the future expansion of the plant.

Before any work can be done on the building's design, a site for the plant must be chosen, which requires careful thinking. If the site is wrongly chosen, it may lead to a costly venture and difficult to correct situations such as:

1. Heavy transportation rates for incoming and outgoing materials from the plant
2. Heavy cost for labor and difficulty in having services like water, electricity and waste disposal
3. Reduced profits due to competition for getting raw materials as well as sale of products.
4. Legal complications if the local community objects to have the plant in the area
5. Restricted future expansion due to site conditions

8.2 Selection Criteria for dairy building site

After selecting the general location for the plant, one needs then to select the actual site on which the building can be constructed. In order to make this decision one needs to consider the following:

- (i) Whether a sloping or level site is required?
- (ii) Access to the location - are roads suitable and is a rail link required?
- (iii) Has the land or site been contaminated and what is the underlying geology?
- (iv) Will planning permission be granted?
- (v) At what level is the water table and what is drainage like?
- (vi) What utilities are available - water, gas, electricity, etc.
- (vii) Security, in particular access and boundaries.

Since dairy plant and products and products manufactured in it have direct public reaction, it is therefore important, that, the site should have a good landscape. Advertising value plays a great part in site selection as well as in external plant appearance. To have a good business and sales, it is suggested to have a thorough check up on the topography of the place and the other factors.

Topography of the site means detail description or representation of natural and artificial features on the map of the place where dairy building is to be constructed. The topography will immediately point out to local services available, location of the sewer line, municipal water lines, zoning and planning of area, restrictions, conditions obtaining in the area and nearby surrounding etc. After studying topography of place, necessary corrective measures may be taken to ensure the suitability of the site

Some typical factors for site selection include size of area available, layout and orientation, drainage, freedom from flooding, any utilities already in place, subsoil, excavation and foundation considerations. Further, Gullies, streams etc. have to be bridged. Any abnormal grading or landscaping problems, any pipelines or other utilities to be relocated. approach to main road and highway. Certain commercial services near the site selected, which are to be considered include facilities for major repair shops, electric motor maintenance, product distributors, lubricants, sanitary materials, engineering department supplies, stationary, local trucking, railway, postal service, air conditioning service and professional service.

The site selected for dairy plant should be suitable for space requirements as well as for the needs of future expansion. The cost of site should be considered together with the development cost, including such items as the provision of rail road or dock if waterfront site is selected. The availability of drainage facilities and the costs of sewage disposal should be checked. Level and firm bottom land is desirable for all sites. The character of the underlying strata and their suitability to support structures at low cost should be considered. Soft underlying formations increase costs because expensive piling is required. Although top-rock formation raises the cost of constructing sewage disposal system, pipelines undergoing tanks and deep foundations required for equipment, it reduces cost of building construction. The cost of plant, therefore, is to some extent determined by the site. The shape and size of the land plot on the site may have an important influence on the layout. It must allow for possible future expansion requirements. The plot plan of the site should be developed in such a way that there is no wastage of areas.

It is important, that the nature of ground at the site conforms to certain requirements. The upper layers of the soil must allow easy drainage as is the case with gravel, sand and the like, so that, water quickly disappears from the surface. At the same time, the ground should provide a firm foundation for roadways and surfaced areas. The subsoil should be firm at the depth for the foundations of the building. Sites with loose clay, shifting sand or high water table should be avoided, as the foundation work on such ground will be both expensive and time consuming. Before making a final choice of site, trial holes should be dug where the building is to be erected. At the same time the subsoil water level in the wet season should be checked to make sure that it is at an appropriate depth.

It is also necessary that the site selected should have transportation facilities, so that, raw material can be easily transported to the milk processing plant and disposal of dairy products to local depots, milk booths or milk parlours does not pose any problem. Delivery trucks, insulated milk tankers, and other vehicles directly or indirectly related to dairy factory should have ample parking space at site along with garage facilities for washing and lubrication. There should be wide roads, and traffic pattern has to be planned in such a manner at site so that, incoming vehicles do not block the passage of outgoing vehicles. Site should have convenient approach from main road or highway. If the site selected is near railway station, it will be beneficial to have railway siding touching the dock at dairy plant.

In addition to the dairy company deciding if a site is suitable to meet its requirements, the impact of the factory on the surrounding area needs to be assessed. The normal method of assessing the impact of a factory on the surroundings is to carry out an environmental impact assessment. In addition one may also wish to carry out lifecycle analysis. The assessment should include the following key issues:

(i) Waste disposal

(ii) Potential hazards to local community

- (iii) Pollution - gas, liquid and solid
- (iv) Noise levels - day and night
- (v) Effect of the facility on the use of local raw materials
- (vi) Transportation infrastructure

8.3 Planning the dairy building on site:

1. Locate the building about 45 m back from highway. This will allow some space surrounding the building even after a highway-widening project.
2. Traffic should be planned to ensure safe movement of all vehicles and pedestrians. Places where pedestrians need to cross roads should be avoided. Truck and automobile driveways should be segregated close to the entrance with clear distinction for visitors. Soiled vehicles that could pose a sanitation risk to the product should be routed in a different way to avoid contamination. Roads should be kept in good condition to avoid damage to products in transit.
3. Provide driving access to all sides of the buildings, if possible. This allows for one-way circulation and will allow fire-fighting vehicles to have access where needed.
4. Rail sidings, parking lots for trucks and automobiles, trash collection areas, and “surplus” equipment dumps can become a source of contamination and a breeding place for vermin. These areas should be kept groomed and drained to prevent contamination to food products by seepage.
5. Locate loading bays at the rear of the building. A gentle slope from the front to the rear will cause the floor of the building to be about 1 m above grade without cutting or filling.
6. Grade the site for natural drainage to ditches. In some areas, grading must be done so that all surface water will be channeled into a storm drain system. Surface water must never be allowed to enter the waste drain system, because water treatment costs are also based on volume.
7. Provide access to the truck building and weigh scale.
8. Locate employee and visitor parking at convenient entry points to the building.
9. Truck parking should be separate from the other parking areas and could be fenced.
10. Raising outside equipment about 20 cm above the pavement will prevent it from being used by rodents as a breeding place.
11. Landscaping and gardens contribute to the company image. Good planning will ensure low initial costs and low maintenance costs. Small recreation areas outside of the plant improve employee morale. Employees should eat in the space provided for them and should not take food outside. Dropped food attracts birds, rodents, and insects, and feeding stray cats or birds on site should be prohibited.
12. Around the base of the buildings, a 1 m grass-free strip covered with gravel or stones are advisable. This controls weeds and is a good area for placing traps and bait.

13. The perimeter should be fenced for security reasons and to prevent children from entering the grounds. This is important if bait-accessible bait boxes are placed outside the plant. Chain-link fences, more than 2 m high, are normally sufficient. The fences will catch pieces of paper, and cleaning them must be part of the overall housekeeping on the site.

14. Orient the building so that its best features and sign face the busiest street.



Lesson 9

Location of Milk Product Plant

9.1 Introduction

The location of milk product plant is decided based on milk product consumption, availability of milk, and other services required. It is advantageous to locate manufacturing plant close to areas where surplus milk is available after meeting the daily requirement of liquid milk. The activities of milk product manufacturing should be centralized to get advantage of economic handling of both fluid milk, seasonal surplus milk and milk products with a better management control. The location of the plant is as per the requirement of dairy machinery and its installation requirements, which decides the building should be of single storey or multi-storey and accordingly site is selected looking to the topological requirements considering water level and application of super structure concept for the building.

9.2 Classification of Dairy plants

· Product Milk Plant

Here, there is the production of products like cheese, butter, ice-creams, etc. which do not require daily distribution to the consumers. So the plant should be located near the producing areas. The difference in the location areas of both plants results in the minimized transportation cost.

Milk plants can be classified based on its capacity:

· Small Capacity Milk Plants

These are usually on ground floor i.e., one level like for liquid milk plant. The milk storage tanks can be easily be placed in the processing rooms. Also the laboratory is connected to the milk reception room. The despatch should be placed next to the storage. The arrangement should be such that keeps the flow in view and all pipes should be kept as short as possible. A wall should be made in such manner that allows a provision for future expansion.

· Medium Capacity Milk Plants

The capacity of the medium sized dairy plant ranges from 20,000 lit to 1, 00,000 liters of milk handling per day. Layout for products like market milk, butter & ghee and cheeses can be designed. Each room should be planned separately and arranged with forward flow of product as per requirement.

· Large Capacity Milk Plants

Here, the plant building may have few floors having multi-product manufacture, where the reception is done at the ground floor and should have both milk treatment and tank storage on the first floor. If products like milk powder are to be manufactured, then the powder plant should placed in different building.

A few points mentioned below will help in determining the location of milk product plant:

(i) The plant should be located at a place where transportation facilities are available, such as railway siding or near highway. It should be noted that, suitable site would always provide easy transport of raw material to the plant and disposal of finished products.

(ii) To avoid contamination, the bulk transport of pasteurized milk should be discouraged. If pasteurized milk is to be distributed in glass bottles or small containers which are to be returned for reuse, the dairy should be situated close to consumption area. For any reason, if dairy is situated far away from consumption area, it is necessary to transport bottled milk in large quantity to local depots equipped with cold storage facilities.

(iii) Advertising value also affects the location of the plant. For instance a plant installed by the side of a heavily traveled highway naturally commands good sales.

(iv) Location of building should be such, that, all necessary services e.g. electricity, water, waste disposal are available at reasonable cost.

(v) The site must be large enough and of suitable shape to give freedom in planning the building and to allow space for future expansion.

(vi) The area should be free from atmospheric pollution.

(vii) Adequate labor must be available at site and it may be necessary to provide housing facilities to workers.

(viii) Traffic congestion around the plant should always be avoided. Larger plant will require more land for smooth control of traffic pattern.

For any entrepreneur desirous of setting up a dairy industry, it is advisable to go through the following check list on 'Location' to assess its suitability. A milk product plant can be located preferably in a village location due to the following reasons;

1. Proximity to the milk shed, reduced transportation cost for raw material
2. Increased shelf life of the product when compared to the raw material
3. Availability of cheap land and labor
4. Reduced noise and pollution
5. In many cases the volume of the final product is less than the milk used, hence reduction in transport and handling cost eg: Cheese, Butter
6. Solid products can be transported in trucks
7. Some products doesn't even require cold-storage



MODULE 4. PLANNING AND PRINCIPLE OF DAIRY PLANT LAYOUT

Lesson 10

Importance of planning and principles of dairy plant design

10.1 INTRODUCTION

Dairy Plants are engaged in processing of milk and manufacture of various dairy products. It is estimated that about 20-25 % of the milk produced in India is being processed by organized dairy plants. The planning of dairy and principles of dairy plant layout mainly depends on the type of the products manufactured and the capacity of the plant. It is necessary to consider both the supply of raw milk and market for processed milk. The earlier concept of locating liquid milk plant near the urban areas is changing and the trend is to locate the plant where the availability of milk is more. The availability of manpower, transportation, source of water and disposal of effluent are also to be considered for the planning of dairy plant. Dairy processing plants can be divided into two categories.

- Fluid milk processing plants involving the pasteurization, flavored milk, butter milk, dahi, paneer etc.
- Composite product plant engaged in processing of milk and manufacture of different products such as cheese, butter, milk powders, frozen products etc.

Dairy processing aspects are changing continually and many new technologies are being used in dairy industry in order to improve productivity, use of automation, manufacture of value added products and conservation of energy.

10.2 Raw Milk Collection and Reception

The milk is collected from the milk producers' society and the collected milk in milk cans is transported through truck to milk processing plants. As the time spent for transportation of milk from remote places together with warm environmental conditions, the sour milk percentage was higher. Therefore, the concept of establishing chilling center at appropriate location came in to existence to cool the milk in the respective chilling center and the chilled milk is transported to the milk processing plant. When the milk is received in cans, it requires milk reception dock having facility of milk weighing, can conveyer, can washer etc. is required at planning stage of dairy plant. Conversely, chilled milk collection and transportation in insulated tanker requires bay to unload the milk from the tanker. The present trend is to chill the milk immediately as soon as it is received at the milk producers' society by using BMC which has improved the quality of raw milk received on the plant. Therefore, based on the way of reception of milk, different principles are required for dairy plant layout.

The capacity of the plant and level of automation required in the plant are also important in design of dairy plant. It is also necessary to consider CIP method at the stage of planning a dairy plant. Source of water and its distribution is a factor to be considered at planning stage of a dairy plant. Depending on the method of milk collection and reception, it is necessary to plan the reception dock.

10.3 Processing of milk

The equipments such as milk pasteurizer, separator, homogenizer, cream separator, etc. are required to be installed in the processing room. The planning of this section is carefully done considering size of the

equipments and working space required for ease of operation. Cream separator and bactofugation require more working space in order to dismantle and assemble these equipments. This section also requires to accommodate milk pipelines to transfer the milk. In many dairies, the cream separation and clarification is carried out using self-cleaning separators. The separator also discharges sediment consisting of dirt particles, udder cells, and bacteria, and leucocytes, which normally is collected or led to the wastewater drain.

10.4 Manufacture of dairy products

The product mix of the dairy is very vital to decide the planning of dairy plant. The product mix may be cheese, butter, milk powders, etc. The planning of various sections considering size of equipment, space requirement etc. should be considered. The housing of milk condensing plant and spray drying plant requires detailed specifications at the stage of planning of dairy plant. The height of the building and provision to access all components of the condensing and drying plant is one of the important requirements in planning of this section. All heavy equipment such as batch type of butter churn may be installed on ground floor with adequate strong foundation.

10.5 Importance of planning and principles of dairy plant design

It is very difficult to develop perfect plant layout for all categories of equipment and services. The ideas of several persons are usually required to make a planning of a dairy building. The provision of future requirements is also to be considered as far as possible. It is noticed in many plants that it is not possible to install a single HTST plant in the existing building to handle more milk. Therefore, it is necessary to consider additional capacity requirement for the next 5-7 years. The adequate provision for offices, laboratory, storage etc. is one of the essential requirements in the planning of dairy plant. The dairy plant layout involves room arrangements and equipment layout considering all technical aspects.

Thus, planning is the way of proceeding or scheme of arrangement for executing any work or project. Planning of dairy plant and adopting principles of design play an important role in the successful running of a dairy plant with desired quality and quantity of output. A well planned design using salient principles of planning helps in following ways.

- Convenience of working
- Ease of handling the operation
- Easy maintenance
- Safety
- Better productivity and labor saving

Advantages of planning and principle of dairy plant designing are mentioned.

- Better hygienic conditions and minimum losses.
- Accommodation of future expansion
- Reduction in processing cost
- Optimal height reception dock improves the working efficiency of worker

- Safety of persons working in the plant.
- Better use of services such as water, electricity, refrigeration, air supply etc.
- Better space utilization for equipment and services. .
- Quick communication with different sections of dairy.
- Efficient utilization of manpower.
- Efficient movement of product within the plant and dispatch
- Energy saving
- Saving on building cost

Utilizing principles of planning and applying them for plant construction leads to economical and effective running of plant. The use of scientific, technical, and logical knowledge can form a model plant for dairy. The planning of dairy plant is more important as compared to other industrial plant due to the requirement of hygienic conditions and perishable nature of milk and milk products.

10.6 Dairy building planning

The elevation of dairy building should give advertizing image to the people. The form and shape of dairy building is important as it affects the public reaction as well as upkeep and initial cost. In addition to several technical considerations, marketing of dairy products needs good site selection and attractive building design. Appearance and look are the primary factors affecting the marketing of the products. If a brand is having a typical pattern of building replicated at many places the building pattern itself may become identification for the brand of the organization.



Lesson 11

Dairy building planning

11.1 INTRODUCTION

The planning of dairy building is the main activities for establishment of dairy plant. Planning is the way of proceeding or scheme of arrangement for executing any work or project. Designing a dairy plant layout is a joint venture of Architects, Dairy Managers, Dairy Engineers and Administrators. It is necessary to consider all technical aspects and economical considerations. The ideas of several technocrats are sought and based on the suggestions of all concerned, actual building planning is worked out. The requirement of utilities such as water, refrigeration, steam, electricity etc. is carefully estimated while planning a dairy. The planning of dairy building depends on capacity, product mix, size of equipments, work space to be kept, future expansion requirement etc. There is no any blue print to be used for design of dairy building. It varies from plant to plant even though the capacity and product mix is the same.

11.2 Dairy plant layout

The main objective of dairy plant layout is to design the dairy plant to carry out all dairy processing operations. The knowledge of estimating the requirement of various equipments, location of equipments in different sections, space requirement for equipment and the general civil aspects of building construction. The engineer should have very clear and complete understanding of requirement and management policies. The management policies decide the future expansion requirement of a dairy plant. Management decision with respect to the addition of new of products is important to be considered at the stage of dairy plant layout. It also includes process schedule to be followed and requirement of different utilities.

A well designed layout must facilitate production operations, minimize material handling maintain flexibility of the operation for alteration and expansion, minimize investment in equipment, make economical use of floor area, promote effective utilization of the labor and provide for employee convenience and comfort.

It is up-most important to design optimum size of dairy building. Some enterpriser engages an architect to prepare the plant layout for an attractive design and consult dairy equipment manufacturers for ideas regarding latest machinery. However, involvement of dairy engineer in the layout is very vital to take care of all necessary requirements. It is advisable to make judical use of land available and optimum cost in construction of building.

11.3 Important factors for planning of dairy building

The following are the basic factors which must be considered before planning the dairy building.

- Milk handling capacity and variation in milk handled every day.
- Method of milk collection and transportation
- Design of milk processing section.
- Method of milk packaging.
- Way of milk distribution to consumers
- Source of electric power supply, water supply and waste water disposal.
- Type of fuel for boiler.
- Provision for subsequent future expansion.
- Transportation facilities and conditions of road

The source of water throughout the year is very important in design of the plant. Water may be distributed by gravity system or hydro-flow system using G.I. pipelines. If power shut down is frequent, then provision should be made for standby availability of electric power. It may not be possible for large plant to have diesel electric power generator for total load of the plant. But partial requirement of electrical power generator facilities is necessary to carry out essential low power consuming operations. The method of effluent treatment system is to be considered at the design stage of the building and provision is made for disposal of treated water.

11.4 Planning of dairy processing schedule

Process scheduling means arranging the flow of products through various operations in the plant in order to achieve maximum use equipment and labor, and the processing of the products is accomplished in the shortest possible time with minimum delays between processing of different products.

11.5 Operational layouts

Operational layouts describe operations which take place in processing or manufacture of different products. All operations involved are represented diagrammatically in chronological way (sequence-wise flow diagram) which can be easily understood by a layman. Even operational layouts can be shown in pictorial views or three dimensional layouts. Such layouts would help to understand the sequence of operations to be followed for the manufacture of various products.

11.6 Principles of dairy layout

A dairy plan engineer should try to incorporate all the fundamental aspects listed below. This would help in performing dairy activities economically and efficiently.

1. The milk path should be as short as possible. This will minimize the cost of pipeline and cleaning time.
2. Reception and dispatch must be arranged in such a way that congestion of transport vehicles is avoided.
3. As general guidelines, a small dairy may have reception and dispatch on one dock but it is necessary to have them separate for large dairy plants.
4. Where space is available, single storey building is most suited. The plan may have a rectangular shape with roads on all sides.
5. Location of milk silo outside the building area may save space and construction cost. This is widely followed in almost all dairy plants.
6. As far as possible refrigeration and boiler section are kept little away on the side of the building on ground floor. Refrigeration machinery room should be near the process room and cold store to reduce the piping cost and pressure drop.
7. Laboratory should have easy approach to reception room and processing room.
8. Separate building block for administrative offices

11.7 Product storage

There are two types of storage rooms required for dairy plants.

- Products stored at room temperature e.g. milk powder
- Products stored at lower temperature e.g. milk, butter, ice-cream, cheese etc.

The design of cold storages requires careful planning to store the product at lower temperature. Pasteurized milk is stored at 3-4 °C while ice-cream is stored at – 25 °C. Therefore, separate cold storages are required for different dairy products. The capacity of cold storage and cooling load calculations are necessary for the design of the cold storages. The frequency of dispatch and period of storage required are essentially required for design of the cold storages.

11.8 Selection of equipment

The selection of equipments before the actual design of building is necessary to decide the space and input required for these equipments. Some equipments are very large which are required to be installed before the construction of walls of the building. The distance to be kept between the equipments is also important to decide the ease of opening the equipment for maintenance purpose. Specifications of each equipment is necessary to be decided at the time of planning of dairy building.

***** 😊 *****



AGRIMOON.COM

All About Agriculture...

Lesson 12

Preparation of process schedule

12.1 INTRODUCTION:

Process schedule is one of the important activity of planning, before diverting milk to different section for product manufacturing. It is prepared well in advance to give instructions to boiler operator, refrigeration plant operator, different process section in charge to plan for the activity of different unit operations for processing the milk to have smooth operation of the process. It also helps to prevent product losses and to have efficient use of equipments, energy and water.

12.2 PLANNING FOR PROCESS SCHEDULE

Preparation of process schedule is one of the important tasks in dairy for a technologist in order to prevent losses in terms of manpower, energy, services, and time. A well planned time schedule will help in preventing losses as well aid in routine work viz. Maintenance, breakdown, establishment etc.

After careful consideration of dairy building planning mentioned above, a process scheduled layout is drawn. Process scheduling means arranging the flow of products through various operations in the plant in such an order that maximizes use of all labor and equipment, and the processing of the products is accomplished in the shortest possible time with minimum delays between processing of different products.

First of all ‘Basis of Dairy Layout’ is drawn according to item of manufacturer to decide definite line flow. To this skeleton layout are added as other information, such as operating rates, storage capacity, raw material required, man power required etc. as each section of plant is considered in relation to the equipment available.

Planning for operations involved in processing of any dairy product has to be done in advance so that maximum use is made of men and material with little waste of time. Process schedule which is more or less work plan ensures that the proposed operation will run smoothly. It provides the basic information from which schedule of service requirements and list of equipment can be made. Time and operation graph can be made which will indicate at what time particular operation has to be performed. It may be noted that all operation for manufacture of any particular dairy product cannot be started at time. There must be a sequence for performing an operation in the plant and that is why the process schedule is required.

The features of the plant considered during preparation of process schedule are:

- Reception capacity,
- Unit processing cost,
- Frequency of CIP,
- Installed capacity of the plant,
- Handling capacity of the plant,
- Running hours and Idle time of plant,

- Quantity of milk received in different season,
- Capacity of the various equipments installed for the processing and production purpose viz. PHE, SEPARATORS, PUMPS, TANKS, VAT, etc;
- Capacity of the services and providing machines viz. Air compressor, refrigeration, boiler, water, ETP, etc;
- Product dispatch timing

12.3 Example of a Process schedule of a milk-processing plant handling approximately 1.5 lakh lit of milk in morning and evening:

Milk is received two times in a day approximately 82,000 lit in evening and 68,000 lit in the morning.

Considering the processing capacity of the plant 20,000 lit /hr.

Morning

Sr. No	Process	Start Time	End Time	Total Time
1	Sterilization of plant	7:30	8:30	01:00
2	Milk processing	8:30	13:30	05:00
3	CIP	13:30	16:40	04:10
	Hot water Rinsing	13:30	13:45	00:15
	Lye circulation	13:50	14:50	01:00
	Hot water Rinsing	15:00	15:15	00:15
	Acid circulation	15:20	15:50	00:30
	Hot water Rinsing	16:00	16:15	00:15
	Lye circulation	16:20	16:30	00:10
	Hot water Rinsing	16:30	16:40	00:10

Evening

Sr. No	Process	Start Time	End Time	Total Time
1	Milk processing	20:30	01:00	04:30
2	CIP	01:00	16:40	04:10
	Hot water Rinsing	01:00	01:15	00:15
	Lye circulation	01:15	02:15	01:00
	Hot water Rinsing	02:15	02:30	00:15
	Acid circulation	02:35	03:05	00:30
	Hot water Rinsing	03:10	03:25	00:15
	Lye circulation	03:30	03:40	00:10
	Hot water Rinsing	03:40	03:50	00:10

***** 😊 *****

Lesson 13

Space requirement for dairy plant

13.1 Introduction

The space requirement for dairy plant should be estimated for its functional design to have smooth operation. The space requirement of entire dairy plant is estimated by adopting principles of dairy plant layout. It is a basic requirement to estimate the total area required for the dairy plant which include building area, parking, movement of vehicles, roads, ETP etc. The type of layout varies considerably for the same plant after having estimated the space and area requirements for different sections. Land requirement is one of the basic cost factors of the plant and land cost has increased considerably in last decades. Therefore, it is important to design the plant with cost effectiveness. According to size and shape of the plot, the most befitting type of layout is selected and all sections are planned in accordance requirements.

13.2 Area and space requirements for milk plants

Space required for equipment depends upon the capacity and dimensions of the equipment. There is no any rigid rule to decide the area of various sections. It mainly depends on the idea and judgment of engineer who is designing the dairy plant. General guidelines are given below to estimate the size of different sections.

Table: 13.1 Approximate area and space requirement for dairy equipment

Milk reception dock (single conveyer and weighing pan)	7 m x 10 to 14 m
Can washer	5m x 5 m (rotary can washer), 5m x 20 to 22 m
Horizontal milk tank, 10,000 liters	3m x 5m
Horizontal milk tank, 20,000 liters	4m x 7 m
Vertical tank, 10,000 liters	4 m x 4 m
Process room area, minimum	5-6 times the area of equipment
HTST pasteurizer, 10,000 liters/h	25-30 m ²
Space between two equipment	1-1.5 m
Space between two tanks	1 m
Area of small dairy, 10,000 to 15,000 litres/day	200 m ²
Area of medium size dairy, 40,000 to 50,000 litres/day	300-400 m ²
Area of larger size dairy, 50,000 to 100,000 litres/day	400-600 m ²

Note: For higher rates, equipment will have to be duplicated and upto 60% extra space must be allowed.

Bulk milk storage:

The space requirement for bulk milk storage can be estimated based on the type of storage vessels used (horizontal storage tank, vertical storage tank, silo etc). The space requirement is estimated based on the working space required around the tanks and necessary equipments installed around the tank. It should also facilitate the cleaning operation, manually or CIP.

Table: 13.2 The approximate space required to accommodate tanks and the associated piping,

Particulars	Area
Approximate plant area	1 to 2 sq.ft./gallon of milk handled per day
Plant area for volumes under 20,000 pounds/day	3 sq. ft./gallon 1 IMP gallon=1.20 U.S. gl.
Refrigerated milk storage room area Approximate	5.25 gallons/sq.ft.(for round bottles) gallon milk/sq.ft.(for square bottles)
Process room area minimum	$A=5a$, where a = area of the equipment space
Minimum space between the equipment	3 ft. (90 cm)
Working space around the equipment	3 ft. (90 cm)
Minimum space between storage tanks	2 ft. (60 cm)
Processing room ceiling height (min.)	10 ft. (300 cm)
Recommended height	12 to 15 ft. (366 cm to 458 cm)
Processing room ceiling height if visitor's gallery is to be provided	20 to 25 ft. (600 cm to 750 cm)
Height of cold storage room (min.)	8 ft. 6 inch (260 cm)
Bottle washing room area	Bottle washer area + crate washer area + space for conveyors + area of cold storage room
Dry storage area	25 per cent of the total plant area
The refrigeration machinery room (compressor, ice-builder etc.)	Fluid milk plants require 0.6 to 1.0 sq.ft. of floor area per hundred wt. Of milk handled/day. 1 sq.ft./112 lbs of milk handled per day
Boiler room	Excluding fuel storage, a boiler room will usually be from 0.4 to 0.8 sq.ft. for each 100 lbs of milk handled per day for a fluid milk operation.

Including access for cleaning is as follows:

Vertical tank 5,000 litres	3.5 m x 3.25 m
Horizontal tank 10,000 litres	3 m x 5 m
Horizontal tank 20,000	3.5 m x 7 m

13.3 Space requirement for different sections of dairy plant:

Allotment of the space for the specific section and to the specific plant and equipment is a matter of thinking so as to provide sufficient space to each plant and equipment for better functioning at the place for worker. Less space will create congested atmosphere and may cause accident at work in hurry some time; whereas unnecessarily providing more space may cause shortage of land in future and will cost more for maintaining cleanliness. So the space provided for a section should be sufficient enough for working freely and comfortably, which should be planned well with concept of expansion in future also. The sections like boiler, electricity and refrigeration should be kept in isolated area to safe guard the plant from accident and damages

The decisive factors which are to be kept in mind during construction of plant for space are:

- Size and the capacity of the equipment i.e. Height, length, width, etc.
- Type of operations to be carried out
- Future expansion

Table: 13.3 The approximate space requirement for different section and equipment are given below:

Sr No.	PARTICULARS		SPACE REQUIREMENT
1	Milk reception, Inspection, accumulation space and skim milk filling		5 x 10-14 m
	Tipping and weighing		5 x 6 m
	Rotary can washer (3-4 can/min)		4 x 4 m
	Straight through washer(8-10 can/min)		5 x 20 m
2	Overall space requirement: Upto 10,000-15,000 lit/day		80-100 m ²
	Upto 20,000-50,000 lit/day		100-150 m ²
	Upto 50,000-70,000 lit/day		150-200 m ²
3	Bulk storage		
	Vertical tank (5,000 lit.)		3.25 x 3.25 m
	Horizontal Tank (10,000 lit.)		3 x 5 m
4	Milk processing		
	HTST Plate pasteurizer(Upto 10,000 lit/hr)		25 m ²
	HTST Plate pasteurizer (with homogenizer or 2 separators)		36 m ²
5	By-productive section:		
	Overall space requirement		
	Upto 1,000 kg butter/day		50 m ²
6	Milk powder section:		
	Evaporator (1,000 lit of water/hr)		30 m ² x 3.5 m
	Evaporator (9,000 lit of water/hr)		50 m ² x 9 m
7	Boiler section:		
	Boiler capacity		
	500 kg/ hr		Horizontal 2 x 3 x 2.5 m
	2,000 kg/ hr		Vertical 1.5 m ² x 3 m
	5,000 kg/hr		2 m ² x 3.5 m
8	7,500 kg/hr		3 m ² x 5.5 m
	Oil tank (50,000 lit.)		15 x 5 m

Lesson 14

Estimation of service requirements including peak load consideration.

14.1 Introduction

Estimation of service requirements is important to determine the capacity of equipments used for providing different services in the dairy plants. The major utilities of dairy plants are steam, refrigeration, electricity and air supply. It is necessary to know rate input services required for various equipments. The peak load can be estimated by for various services based on the operating schedule of the equipments. The peak load estimation is also important to make contract for connected electrical load of the dairy. The peak load requirement for steam, refrigeration, electricity and effluent treatment plant is very much necessary. Peak load is calculated based on capacity utilization of equipment and load conditions of cold store, ice bank tank and effluent treatment plant.

Dairy processing plants are traditionally divided into two separate categories for the purpose of production and energy statistical data presentation: fluid milk; and industrial milk. These two categories are described as follows:

- Fluid milk processing involves the pasteurization and processing of liquid milk for direct consumption, as well as creams, chocolate and other flavored milks, and buttermilk.
- Industrial milk processing involves the processing of milk into value-added products. These include cheese, butter, ice cream and other frozen products, condensed and evaporated milk, dried milk powder, yogurt and other cultured milk products. The milk used in the manufacture of industrial milk products is also pasteurized before processing.

For the purpose of this guide, six major generic process sequences (one fluid and five industrial) have been considered. These processes are:

- o Fluid milk;
- o Cultured products;
- o Cheese;
- o Butter;
- o Ice cream and other frozen products;
- o Evaporated/dried products
- o Traditional Indian dairy product.

These generic process/product combinations were selected because they:

- Cover the wide range of product manufacturing activities undertaken;
- Represent the natural groupings of similar generic processes; and

· Coincide with the general process categories separately modelled in support of Hazard Analysis Critical Control Points (HACCP).

14.2 Steam Requirement

Steam requirement is calculated for processing and other purposes separately, while boiler for condensing and drying plant is selected separately, based on the calculation of steam requirement in the condensing and drying plants. After estimation of steam requirement of each equipment on hourly bases, time schedule diagram including each processing equipment is prepared to know the peak requirement of steam in the peak hours. Depending on the peak load requirements, steam pressure is maintained and boiler is started in advance to get required steam pressure and quantity of steam. The main steam line pressure is maintained higher than actually required during peak load hours, considering losses in the lines and number of bends in the line. The fluid milk plant requires approx. 0.25 to 0.4 kg of steam per liter of milk, while that of powder plant requires approx. 5 kg of steam per kg powder.

14.3 Refrigeration Requirement

Refrigeration requirement of dairy plant is mainly divided into two major categories (i) Chilling load and (ii) Cold storage load. Chilling load is referred to the chilled water requirement of different equipments during processing of different products. It is calculated based on the chilling requirement of different processes. The chilled water requirement of different processes can be met by Ice Bank Tank (IBT) or Ice Silo. IBT can be designed based on the total requirement of chilled water in the different processes in a day. The refrigeration plant for IBT can be operated during night hours (16 to 18 hours a day). The cold storages are required for different dairy products like ice cream, butter, cheese, milk etc. They are maintained at different temperatures and at different relative humidity depending on type of product to be stored. The cold storage refrigeration plant capacity is calculated based on consideration of different types of loads like product load, wall gain load, air change load, lighting load and miscellaneous load.

Time schedule for different processes which, requires chilled water is prepared to know peak load requirement of chilled water. Similarly time schedule for loading and unloading of the cold storages are also prepared to know peak load requirement of cold storages and accordingly refrigeration plant is operated to conserve energy.

14.4 Electricity Requirement

Electricity requirement for different equipments, pumps, motors, refrigeration plants, lighting and general purpose is calculated based on actual operating load. Depending on the requirement of single phase and three phase connections load distribution is made using necessary controls. All the equipments are provided with safety devices to protect from over load condition or voltage fluctuations. Motors are provided with variable frequency drives and soft starters to conserve energy. Refrigeration plant of dairy contributes approx. 40 to 50% of total electricity load.

14.5 Water Requirement

Water supply for dairy plant is important and must be considered at the planning stage. An adequate supply of pure water for washing of equipment and cooling purpose is essential. An ideal water supply is one that is soft cold and free from all impurities. The water is treated to meet plant requirement by using suitable process. The hardness of the water used in the dairy plant should be maintained below 35 ppm. Generally the ratio of milk: water of fluid milk plant is 1:1, while that of multi product plant is 1:1.5 or 1:2. It depends on type of products made and size of the plant. There are different types of water soft water, well water, chilled water, hot water etc. they are used in the different processes, for cleaning of equipment and floors. The distribution of water can be done by gravity, centrifugal pumps or by hydro flow systems. Hydro flow system is used to have uniform pressure in the water pipe lines, which facilitates operation of automatic control systems. Control of use water is

required to conserve water and to reduce load on effluent treatment plant.

Table: 14.1 Typical Utility and Service Requirements:

UTILITY	DEMAND REQUIREMENTS	SPECIFIC PROCESS
Cold Water: 10°C City 1-7°C Chilled	Rinsing, Washing, Recirculation Cooling, Product Cooling	All All
Hot Water: 90°C 70°C 50 + °C	Pasteurizer Heating Mould Release Washup/CIP	All Ice Cream All
Steam: Approx 790 kPa abs Lower 790 kPa abs	Pasteurizer Heating (usually via Hot Water) Dryer Air Heating Evaporation Water Heating	All Dried Product Evap/Dried Prod All
Thermal: Furnace Boiler Heater	Space Heating Hot Water/Space Heating Dryer Air Heating	All All Dried Product
Refrigeration: -40°C -30°C -9°C -6°C 1°C 4°C	Mould Brine Freezer/Storage Ice Cream Maker Glycol for HTST Chilling Product Holding Cooler Milk/Product Cooling	Ice Cream Ice Cream Ice Cream All All All
Compressed Air	Valve Actuation, Air Blows, Conveying	All
Electrical (Direct Uses)	Conveyor, Centrifuge, Homogenizer, Packaging Unit Drives, Lights, Refrigeration	All

Table: 14.2 APPROXIMATE ENERGY CONSUMPTION IN DIFFERENT MILK PROCESSING OPERATION:

Process	Energy Consumption				
	Heat(steam)			Electrical	Total
	Pressure Kg/sq.cm	Kg steam/lit. milk	Kcal/100 lit. milk	Kcal/100 lit. milk	Kcal/100 lit. milk
Can Washing	-	-	-	-	-
Rotary	3.25	0.51 kg/can	263 kcal/can	13 kcal/can	276 kcal/can
Straight through	4.2	0.43 kg/can	221 kcal/can	13 kcal/can	234 kcal/can
Pasteurization(90% efficiency)	3.0	0.012	750	103	853
Separation	-	-	-	120	120
Homogenization	-	-	-	600	600
Sterilization	-	-	-	-	-
Batch	1.5	0.4	21300	-	21300
Hydrostatic	1.5	0.12	6600	-	6600
Ghee making	-	-	-	-	-
From butter	3.25	0.021	1082	-	1082
From cream	4.3	0.036	1845	-	1845
Powder making (Spacing process)	14.0	-	23000	1790	24790
Bottle washing	3.5	1.3 Kg steam/100 bottle	668 Kcal/100 bottle	95 Kcal/100 bottle	763 Kcal/100 bottle
Bottle filling	-	-	-	52 Kcal/100 bottle	52 Kcal/100 bottle

Table: 14.3 Unit utility requirement approximately for a chilling centre:

Utility	Requirements			Total	3 % loss	G Total (For peak load)
	Milk processing	Can washing OR Chilling	Other			
~				~	~	~
STEAM (kg/hr)	273.703	215	5	493.70 3	14.811 09	508.51409
Electricity (kwh)	52	80	50	182	5.46	187.46
Refrigeration (TR)	49.26	191.95	5	246.21	7.3863	253.5963
Water (Lit/lit milk)	0.5	1.0	0.25	1.75	0.0525	1.8025

Note- Above data are based on fixed assumptions. If the problem occurs and situation changes than the data may deviate accordingly.

MODULE 4. DESIGN ASPECTS OF DAIRY PLANT

Lesson 15

General points of consideration for designing dairy plant

15. 1 Introduction

Dairy industry in India is growing at fast rate and as such, there is need for Scientific Layout and Planning with a view to have model studies by dairy designers, engineers and architects. The term 'Dairying' has been bifurcated into two branches, namely Dairy Husbandry and Dairy Technology. Under the purview of dairy husbandry comes animal breeding, care, health, nutrition of animals, animal housing, clean and safe production of milk, i.e., milching animals in good sanitary conditions. In some organized sectors, milk collection and chilling before milk is transported for processing at dairy factory also forms an activity of dairy husbandry.

The Dairy Technology commences with processing of milk at dairy plant for market milk and various dairy products. The dairy plant layout and design means designing a layout plan for dairy factory, i.e. layout of various sections in dairy building, equipment layout, laying of dairy machines in each section for economical and efficient movement of men and material in the plant. It will deal with all items which are needed for planning and layout of dairy factory, with direct application to fundamental topics, such as location, selection of site for dairy plant, building materials, specific requirement of each section including service sections. It will also touch the practical need of prospective entrepreneurs aspiring to set up a dairy plant. Management and planning of layout of indirectly related sections, such as office and administration block will also find place in this presentation. The treatment of subject matter is descriptive and lucid so that students, teachers and dairy professionals can imbibe the topics discussed easily. Many illustration and diagrams have been given to make the subject crystal clear. Thorough study of the text book will not deprive the learner of various definitions of milk and milk products, terminology of various processing and technical terms as are commonly spelled in dairy technology and engineering.

Milk and milk products, however, impose certain requirements which do not occur elsewhere in food or other industries. These special requirements affect the structure and the layout of the building, the provision and distribution of services and the choice of site. The products of dairy industry – milk for liquid consumption, yoghurt, curd (dahi), cream, butter, ghee and similar products, cheese, milk powder and so on – are foods which play a fundamental part in human nutrition. In any country, therefore, it is in the nation's interest that milk and milk products be available to everyone at the lowest possible rate. The margin of profit which the dairy entrepreneur can expect is limited. Therefore, every possible economy in capital outlay on building and plant should be sought. Planning must be done wisely to make best use of the labor employed and to keep operating costs to a minimum. Materials and method used in building must be such as to give the longest practical life with the minimum of maintenance, in spite of working conditions which are often relatively severe from both the mechanical and chemical points of view. It should also be seen that most of the repairs, alterations or extensions could be done without stopping the production. These characteristics demand closest attention during planning.

There is need for highest standard of hygiene. Milk is most suitable medium for the growth of microorganisms; therefore, every possible measure should be taken to reduce the possibility of contamination, especially after processing. Failure to maintain adequate control of hygiene will spoil the product, it may not keep well or its flavor may change. This will pose problem to sell the product. A good layout design and use of proper materials and techniques make great contribution towards hygiene. Proper cleaning and maintenance of plant and building is essential, so that, there is no contamination. Care should be taken to provide adequate natural and

artificial lighting. Every possible effort should be made to ensure that the building and the site will be pleasant to look at. The architect can provide a good landscape and an attractive outlook. The welfare of the employees must be kept in view. Canteen facilities are essential. Housing for key workers must be provided near the plant at reasonable distance, so that they can reach in time in emergency.

To sum up, dairy plant layout needs careful thought and planning keeping in view manufacture of the products and their commercial aspects.

15.2 Increased safety and improved working conditions

Good plant layout incorporates safety into the plant by eliminating hazards at work stations, in materials handling, storage activities, maintenance operations and the like. Man hour losses can be cut down to minimum. Reduction in losses of capital equipment and materials is another result of “built in” safety in the layout. The provision of a good physical plant environment improves the overall working conditions. Increased employee moral tends to reduce production costs and helps develop a stable operating force.

15.3 Perishable nature of milk

Milk by its nature is perishable. The following three factors contribute to its being perishable;

- (a) Contamination with bacteria
- (b) Warm temperatures, and
- (c) Prolonged time before cooling or processing

In practice, none of these factors can be eliminated completely, so if any one is accentuated, the life of milk will decrease. Therefore, every effort must be made to minimize these factors on the farm, during collection at milk plant and during distribution to consumers. At the farm, the aim must be to cool the milk as soon as possible often milking. Freshly drawn milk has bacteriostatic property, i.e. it contains substances which resist the growth of bacteria for several hours. However, there is a substantial bacterial population. Ideally, the milk should be chilled to 4 °C within two hours after milking. If for any reason this can not be done at farm, quick transport of milk to the plant is essential.

If milk can be stored conveniently at the farm or local collecting depot at low temperature, the organization of transport to milk processing plant is simplified to greater extent by transporting bulk quantity in insulated tankers. The type, size and number of vehicles necessary are, therefore determined not only by the usual factors such as distance or nature of roads but also by the condition of milk production. This applies to cream also. In some cases, the milk may be separated at the farm and only the cream, i.e., milk containing 5 to 30 per cent fat is sent to plant for manufacturing butter or ghee.

15.4 Flexibility

Management should lay stress upon maximum flexibility in production facilities and distribution methods consistent with low cost operations. Production facilities and layout can be designed to attain flexibility and adaptability to meet changing economic and technological conditions. To combat regular fluctuations in the supplies of milk available to processing plant throughout the year, flexibility in the plant layout is essential. Flexibility is necessary since market conditions for the sale of finished products attain flexibility in production changes of the product, and technological advances must be anticipated so that plant equipment does not become obsolete. The amount of production flexibility depends on such factors as the nature of the products, the kind of production facilities can in part be attained by initially selecting universal and standard types of machines, which can perform a variety of operations, such as Tri-process machine used for cream separation,

clarification and standardization of milk. Layout flexibility can also be attained by incorporating into the layout as much as possible the process-layout arrangement whenever it is consistent with low cost operations.

Allowance for increases in capacity can be anticipated in a layout by properly arranging production departments and selecting the type of building that can be expanded at low cost. Sound layout engineering attains low cost flexibility in the kind of operations performed and an ease in the increase of output capacity which may be required for the future.

Good plant layout achieves a floor arrangement that contributes in a number of ways to low-cost production planning and control. Materials control can be more easily attained in a well designed plant layout. A steady amount of production capacity is facilitated an idleness of machinery and man is reduced to minimum. The net result is facilitation of dispatching activities on operating floor. Deliveries to customers on short notices are easily attained.

15.5 Modes of transportation of milk

A mode of transportation of milk depends on type of area, type of transportation available and local road conditions. Table 15.1 shows different types of mode of transport used for procurement of milk, for optimum load conditions and distance.

Table 15.1. Various modes of transportation of milk to dairy plant along with optimum load and distance.

Mode	Optimum load (kg)	Optimum distance (km)
Head load	15 to 25	3 to 8
Shouldering	Up to 30-	3 to 6
Animal (Ponies, Horses, Donkeys)	80	6 to 10
Bullock cart	300 to 400	10 to 12
Tongas	200 to 300	12
Bicycles	40 or more	15
Cycle rikshaw	100 to 150	10
Boat (for crossing rivers)	50 to 200	2 to 8
Auto-rikshaws	250 to 500	15
Motor truck	3 tonnes	15
Railway wagon	11 tonnes	100 or more
Road tanker	5 tonnes	100 or more
Rail tanker	5 tonnes	100 or more

The milk is usually brought to dairy plant either by Road or Rail Transport through cans or tankers. Plus points of these means are given below:

Table 15.2. Mode of transport and their corresponding advantage.

Mode of transport	Advantage
Road	Loading and unloading conveniently done at godowns of sellers and buyers. Cheaper than rail over short distances. Less time consuming.
Rail	Cheaper than road over long distances. Large quantity of milk can be handled at a time.
Can	Small quantity of milk can be handled.
Tanker	Faster mode of transport. Low cost. Better temperature control. Less risk of contamination. Time and labour saving. Low investment in cans. Saving in detergents.

15.6 Milk procurement and reception at dairy plant

In most of the countries, milk production is carried out in rural areas from where it is transported to milk processing plant, and thereafter for distribution to consumers through local depots or milk parlours. Under Indian conditions, milk has to be regularly collected and transported twice a day (morning and evening).

The usual methods of milk collection and reception at dairy plant are:

Milk procurement through individual producers: In this milk is brought to the dairy plant by the individual producers in their own vessels any type. This is possible for those producers who are located nearby milk processing dairy.

Milk collected through co-operative organizations: Here, co-operative societies form an organization which is responsible for uninterrupted supply of milk to the dairy plant. Supply of milk can also be effected by single co-operative society formed by milk producers. This is beneficial to the producers as there is no middle man to share the profit.

Milk procured through contractors: There is less return to the milk producers, as milk contractor will keep his share in the profit.

Milk reception from milk collection cum chilling centers: This method is generally possible and is prevalent in organized sectors, and dairy corporations in India.

Milk is collected at various milk collection centers from nearby villages in 40 litre cans usually belonging to the organization. The milk is weighted, tested for fat content and kept ready to be dispatched to the milk chilling center, where milk cans are emptied, washed through can washer and sent back to milk collection centers for next day collection of milk. Route plan linking villages, milk collecting centers and chilling center is shown in Fig. 1.1. On arrival at milk chilling center, the milk is weighed chilled and transported to milk processing dairy plant through Insulated Road Mill Tankers or Rail Tankers. The important equipment for reception of milk at milk processing plant are

(i) Can conveyor (ii) milk weigh tank

(iii) weighing scale (iv) dump tank with cover

(v) can washer (vi) drip saver

(vii)milk pump (sanitary type) (viii)surface/plate chiller

(ix)refrigeration unit (suitable capacity), and (x)milk testing laboratory

The milk as soon as it is received at plant, it is weighed, dumped into the dump tank (weigh tank) and has to be chilled before it is stored for processing. This has to be done in quick succession through equipment well planned and installed at milk reception dock and receiving room. If the milk is received in bulk through tankers, the arrangement has to be made for quick transfer of milk through milk pumps installed at milk reception dock to milk storage tanks. The milk received in the evening may be chilled and the stored for processing next day. This all will need careful planning of layout of equipment at milk reception dock and milk receiving room. Roads leading to milk reception dock and dispatch dock have to be planned in such a manner so as to avoid traffic congestion inside the factory or road blockage.

15.7 Contamination and its prevention

Milk coming from its source to milk plant for processing is prone to contamination as it passes through different stages, hands and environmental conditions. Unless proper precautions are taken, outbreaks of milk-borne diseases can occur anywhere anytime especially if raw milk is consumed as such. Diseases which are known to be transmissible through milk are given hereunder together with the manner in which they may enter the milk.

Infection of milk directly from the cows: These diseases are essentially bovine. The causative organisms enter the milk through the mammary glands or through contamination, and may cause a diseased condition in persons who consume the milk. Bovine tuberculosis or fever can occur.

Infection from man to cow and to milk: These diseases are essentially human, but can become established in cow's udders, e.g., septic sore throat, scarlet fever, diphtheria etc.

Direct contamination of milk by human beings: These are human diseases, the pathogenic organisms of which enter the milk through contaminated milk bottles or other utensils, water supply, insects and dust, e.g. typhoid or paratyphoid fever, dysentery or diarrhoea etc.

For human consumption, milk must be clean and safe. The sanitation of milk supply can be safeguard in two ways.

(a) Production and handling of raw milk. It should be done in such a way, so as to prevent its contamination by pathogenic organisms. This will require ((a)ensuring the health of dairy cattle by various control measures, (b) safeguarding health of employees by regular medical check ups, (c) protection of water supply from contamination by organisms, (d) straining the milk through milk strainer for any dirt straw etc.

(b) Pasteurization of milk. This will kill all pathogenic organisms and avoid any post-pasteurization contamination.

There are many factors which help in preventing contamination, such as design of equipment, effectiveness of cleaning and sterilization, methods of handling and design layout of building, particularly internal finishes. The end products of processing plant are liquid milk in various forms, cream, butter, cheese, milk powder, ghee, etc., each item is produced to meet consumers requirement. In all these conservation processes, highly perishable raw material is given longer life. Although the various processes are different, but they are similar in sense that they control development of bacteria. It is, therefore, recommended to keep the raw material well separated from the processed products. The isolation of dirty bottle reception and bottle washing from pasteurized milk bottling, storage and dispatch is one of the example of this. Similarly, pipelines for raw milk must be completely separate from those carrying processed milk. Every section of the plant must be independent and self contained as far as possible. For instance, many varieties of cheese involve the growth of

molds to give their characteristic flavour, whereas the presence of mold in butter would damage it. Most of dairy products quickly absorb flavours not only from one another, but also from any strong smelling contaminants such as oil, ammonia, paint or kerosene.

Table: 15.3. Sources of contamination and control methods.

Interior of the udder	<ol style="list-style-type: none"> 1. Check for mastitis. 2. Discard foremilk.
Exterior of the cow udder and flanks	<ol style="list-style-type: none"> 1. Wash and wipe udder. 2. Clip the udder and flanks. 3. Dry milking. 4. Use small top milk pail
Bard air and dust	Keep milk covered.
Files and insects	<ol style="list-style-type: none"> 1. Eliminate breeding places. 2. Fly control with fly sprays, if traps, meshed door etc.
The milker	<ol style="list-style-type: none"> 1. Clean habit 2. Dry milking
Utensils	Clean, sanitize and dry before use.

15.8 Cleaning and sterilization

The dairy industry is somewhat different from other industries so far as hygiene is concerned, and is comparable with medical practice. Every detail of equipment and building design must have medical rather than industrial approach. Every item of equipment which comes into contact with milk must be cleaned thoroughly and sterilized every day. Anything less than this will quickly lead to problems. In hot climate, the problem is intensified. Once trouble starts, it may quickly spoil large portion of the production it may then take several days to control the situation.

With milk pasteurization, daily cleaning may not be sufficient. Where the plant has to operate for more than five hours at a time, it will be necessary to stop for an intermediate cleaning and sterilizing operation. The reason for this is deposit of milk solids heating surfaces, which causes loss of heat transfer efficiency. Dairy equipment, therefore, must be designed so that it can be easily and thoroughly cleaned. Crevices and small internal radii must be avoid. The equipment may be dismantled and thoroughly cleaned. The material used must be corrosion proof. The building should fulfil high standards of sanitation. Every possible effort must be made to eliminate dust and insects. Floors, walls and ceiling finishes must be such that they can be easily cleaned, thus reducing the contamination. Neat and clean dairy is liked by everyone and also makes a good business.

***** 😊 *****

Lesson 16

Different types of layouts

16.1 Introduction:

Planning is the way of proceeding or scheme of arrangement for executing any work or project. Planning a layout for a dairy calls for careful thinking. Designing a dairy plant layout is a joint venture of Architects, Dairy Managers, Dairy Engineers and Administrators, because it is an overall managerial function. The ideas of several technocrats are sought and future requirements are estimated as accurately as possible. The anticipated capacity in 10 years, products to be manufactured, types of packages, methods of distribution, material handling, loading out facilities and office space are the examples of items to be kept in view while planning layout. The plant layout engineering function is to achieve an efficient plant layout through the utilization of logical, well through procedure.

Top management policies affect the plant layout as policies determine the plant layout objectives and scope of plant activities. The layout engineer must have a clean and complete understanding of those top management policies, that have a bearing on plant layout objectives. A knowledge of managerial policy with respect to the future volume of production and the size of business firm is of particular importance to dairy plant layout engineer, because it will point to the need for providing for future expansion or contraction in the layout. Included in expansion programmes are management decision with respect to the addition of new or related lines of products. A plant layout should be so planned and arranged, that the needed capacity to produce new or related products can be added at low cost, with minimum of plant revision and interruption of production schedules.

A good layout must improve or facilitate production operations, minimize material handling maintain flexibility of the operation for alteration and expansion, minimize investment in equipment, make economical use of floor area, promote effective utilization of the labor force and provide for employee convenience and comfort.

Many companies engage an architect to draw up a plant of an attractive design and consult dairy equipment manufacturers for ideas regarding latest machinery. The common mistake lies in making too large or too small a plant. The size of dairy plant is a matter of consideration and prudence. It has often been found unwise and erroneous to construct a very large building in as much as it may not be paying especially in new business. Many concern have faced bankruptcy due to overhead cost on massive construction.

16.2 Principles of dairy layout

As far as possible dairy layout engineers should try to incorporate the following principles in layout, which, in turn, will help in having an economical and efficient dairy plant. It is often seen that the dairy designer or layout engineer is not in a happy position because he is always confronted with one or the other layout planning problem, which makes him unable to apply all the principles described hereunder:

1. The milk route should be as short as possible. This will minimize the cost of pipe length and save time in cleaning.
2. Reception and dispatch platforms must be arranged in relation to plant in such a way that congestion of transport vehicles is avoided.
3. A small dairy handling milk up to 20,000 liters/day may have reception and dispatch at one dock as there will not be much rush of vehicles. In large dairies, this separation is essential. Generally milk reception and dispatch

of washed cans is one side (because washed cans are reloaded on the same vehicle and returned to milk producers) and dirty bottle reception is on the other side.

4. Where space is available, single storey building is most suited. The plan may have a rectangular shape with roads on all sides.

5. The floor level of milk reception and dispatch docks and of all rooms concerned with milk cans and bottles should be at the same height above the ground level suited to vehicles. However, the weigh tank and raw milk pump should be at a lower level in order to have a convenient tipping height. A well or pit must be constructed for the weigh tank and raw milk pump.

6. The raw milk storage tank and pasteurized milk balance tank may be mounted on a staging in order to save floor space and to provide a gravity head to fillers.

7. If it is desired to have a refrigeration compressor room and boiler house in the same building, the floor level of these rooms should be at par with ground level. This gives extra height to boiler and affords a sturdy foundation to compressor.

8. Laboratory should have easy approach to processing room, reception room and filling room.

9. Separate apartments should be assigned for offices.

10. Boiler should be located near the place where steam is required.

11. Refrigeration machinery room should be near the process room and cold store.

12. Security and watch and ward offices should be located near gate.

16.3 Operational layouts

Operational layouts describe operations which take place in processing or manufacture of any item. All operations involved are represented diagrammatically in chronological way, i.e., sequence-wise-what comes next on the paper like any flow diagram which can be easily understood by a layman. There is no restriction in showing pictorial views or three dimensional layouts. For instance, an operational layout of a butter making factory will differ from that of ice cream making plant as two have different operations to achieve end product.

These layouts are usually drawn to impress upon management board which may comprise of professional and non-professional members for quick understanding of the proposed project.

16.4 Typical layouts for different types of product sections of dairy plant :

Typical layouts are prepared for different types of product manufacturing in the dairy plant. The layout should be functional to facilitate each unit operation involved in product manufacturing. Fig. 16.1, 16.2, 16.3, 16.4, 16.5, 16.6, 16.7, 16.8, 16.9, 16.10, 16.11, 16.12 and 16.13 shows typical layout of different product manufacturing sections, integrated product plant and service block.

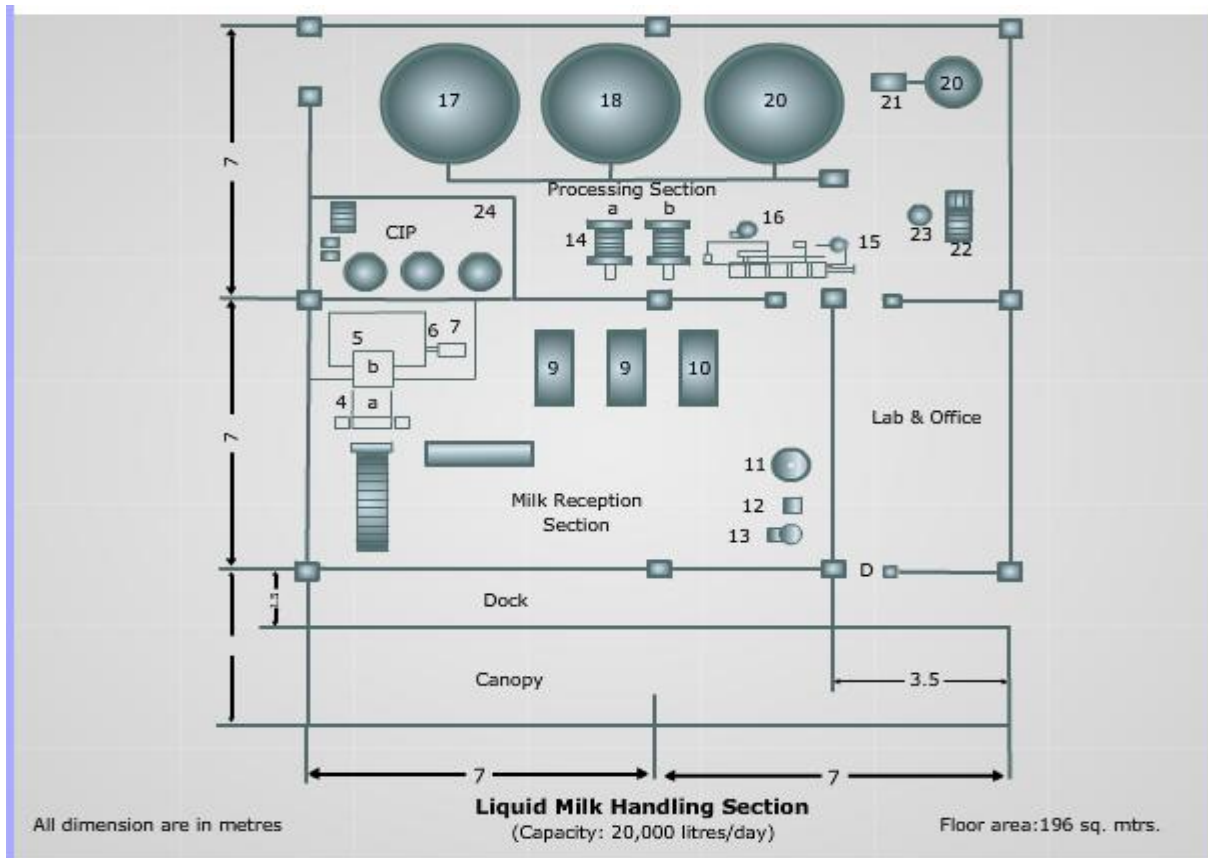

Fig. 16.1 Liquid Milk Handling Section

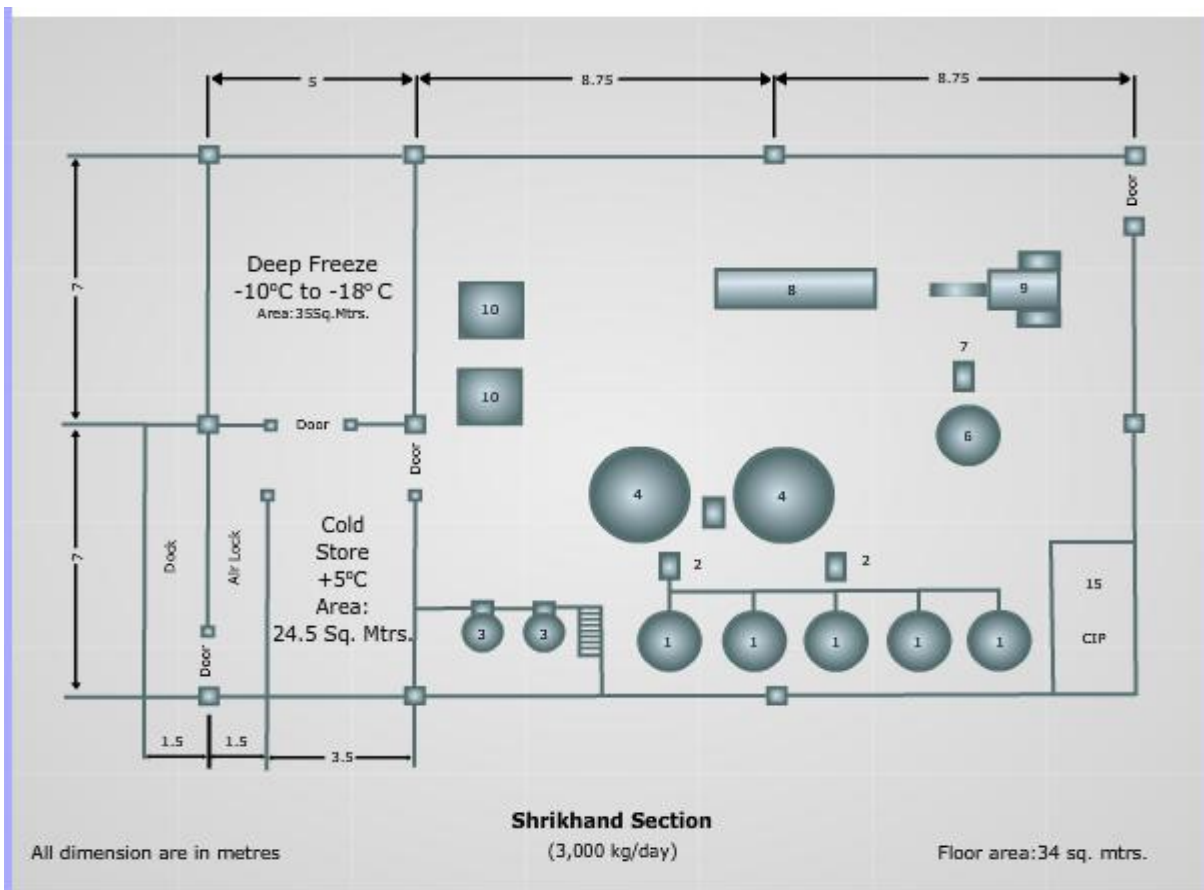

Fig. 16.2 Shrikhand Section

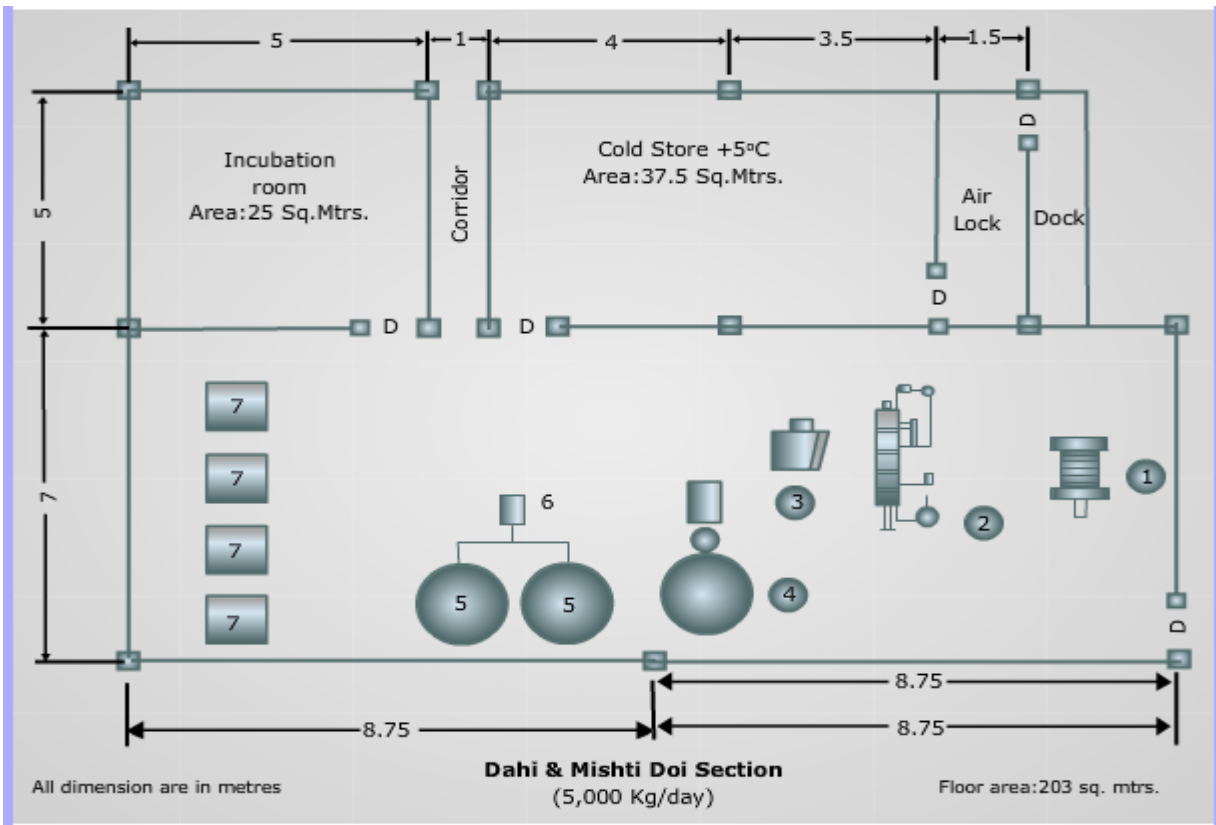

Fig. 16.3 Dahi & Mishti dahi section

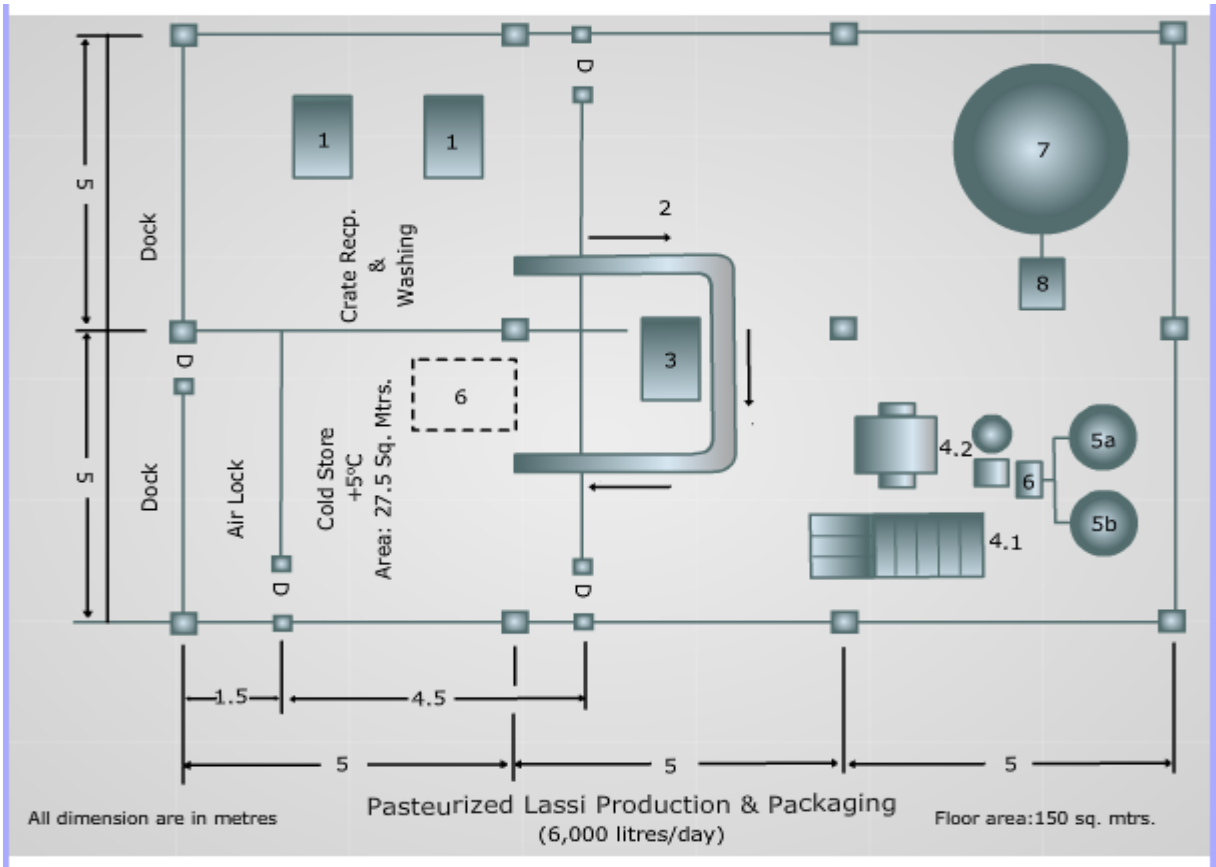

Fig. 16.4 Pasteurized Lassi Production & Packaging

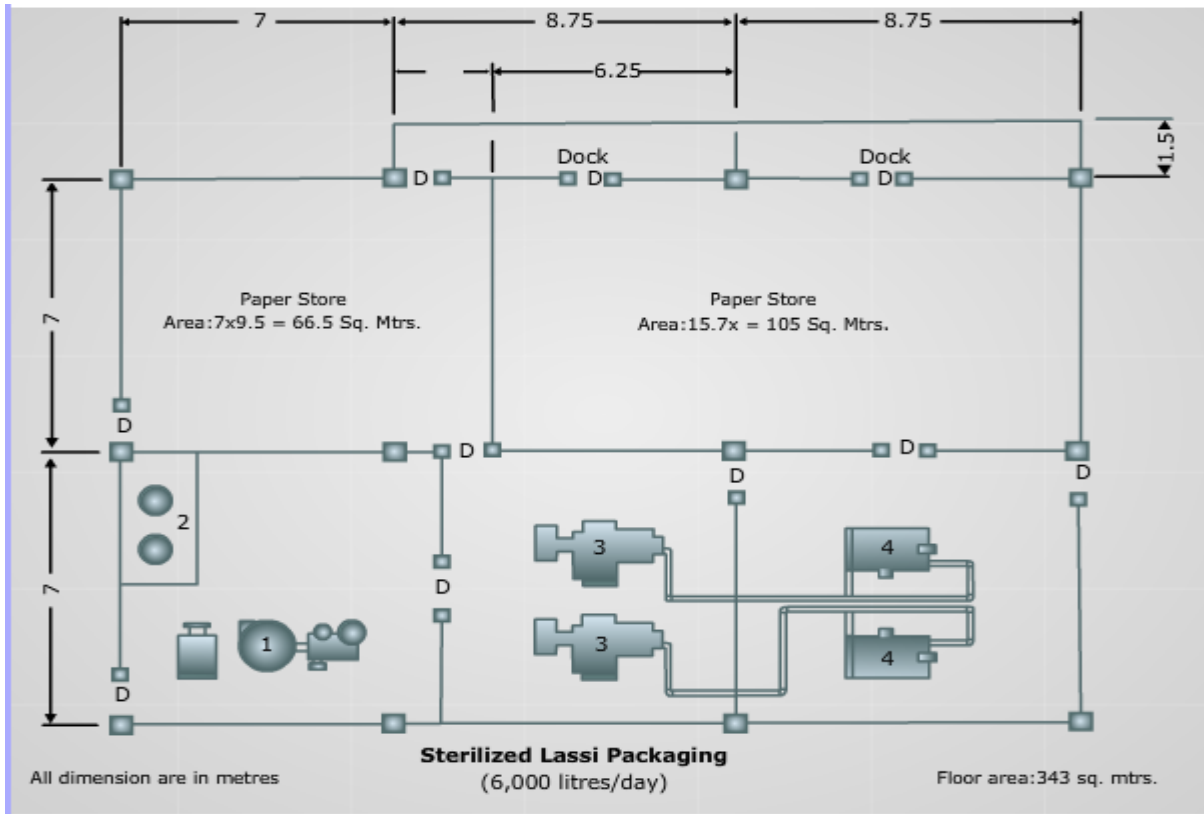

Fig. 16.5 Sterilized Lassi Packaging

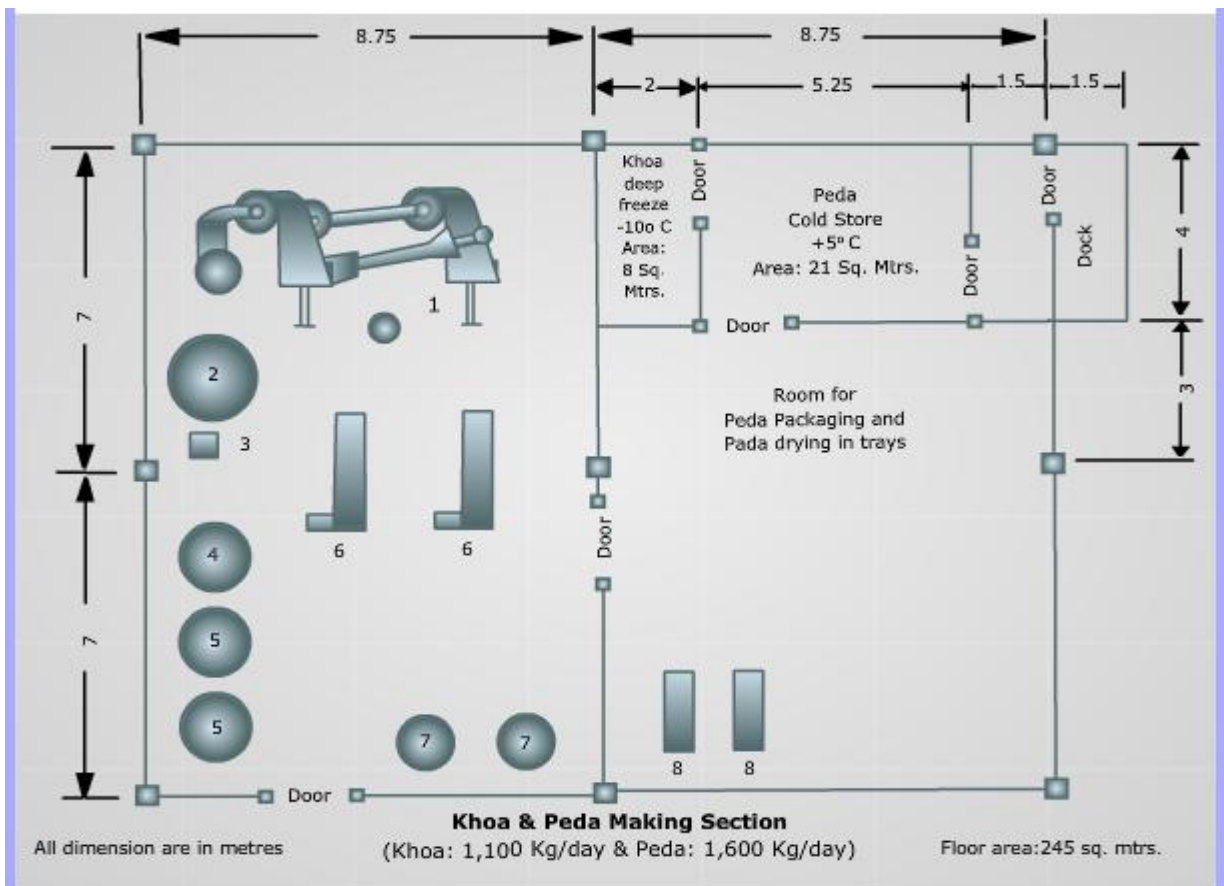

Fig. 16.6 Khoa & Peda Making Section

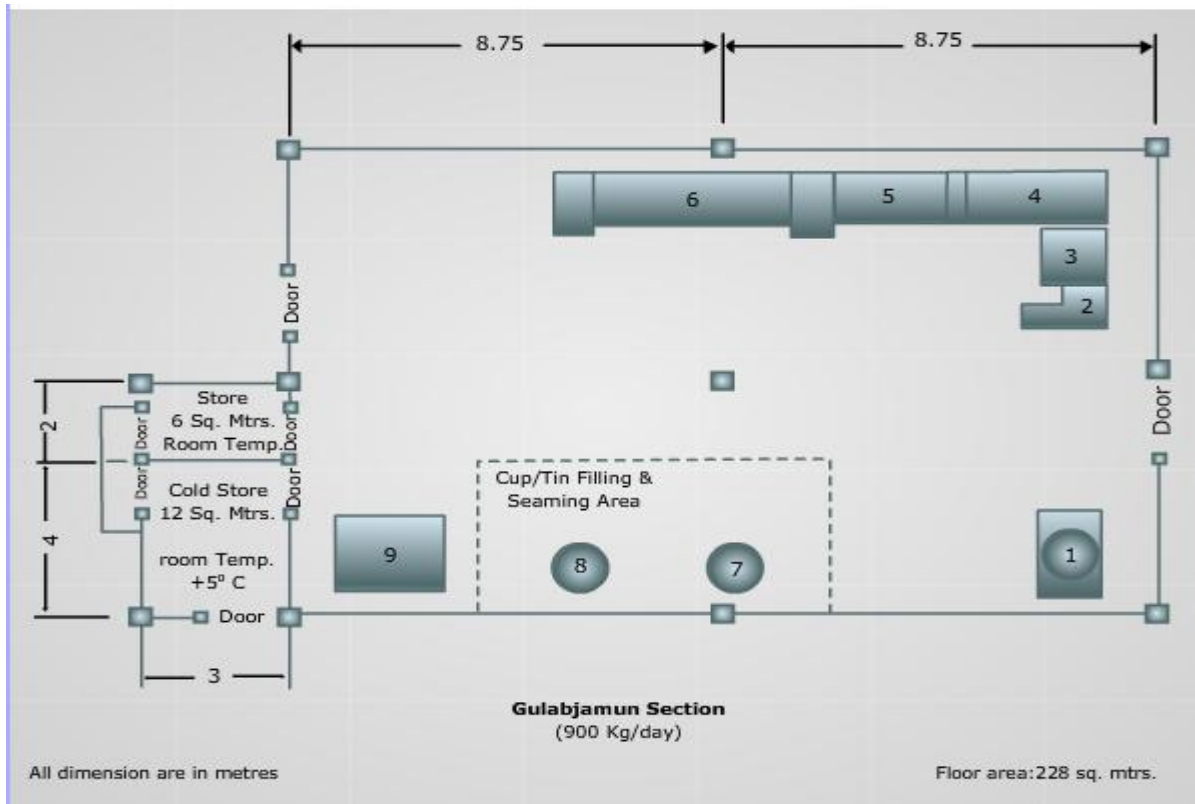

Fig. 16.7 Gulabjamun Section

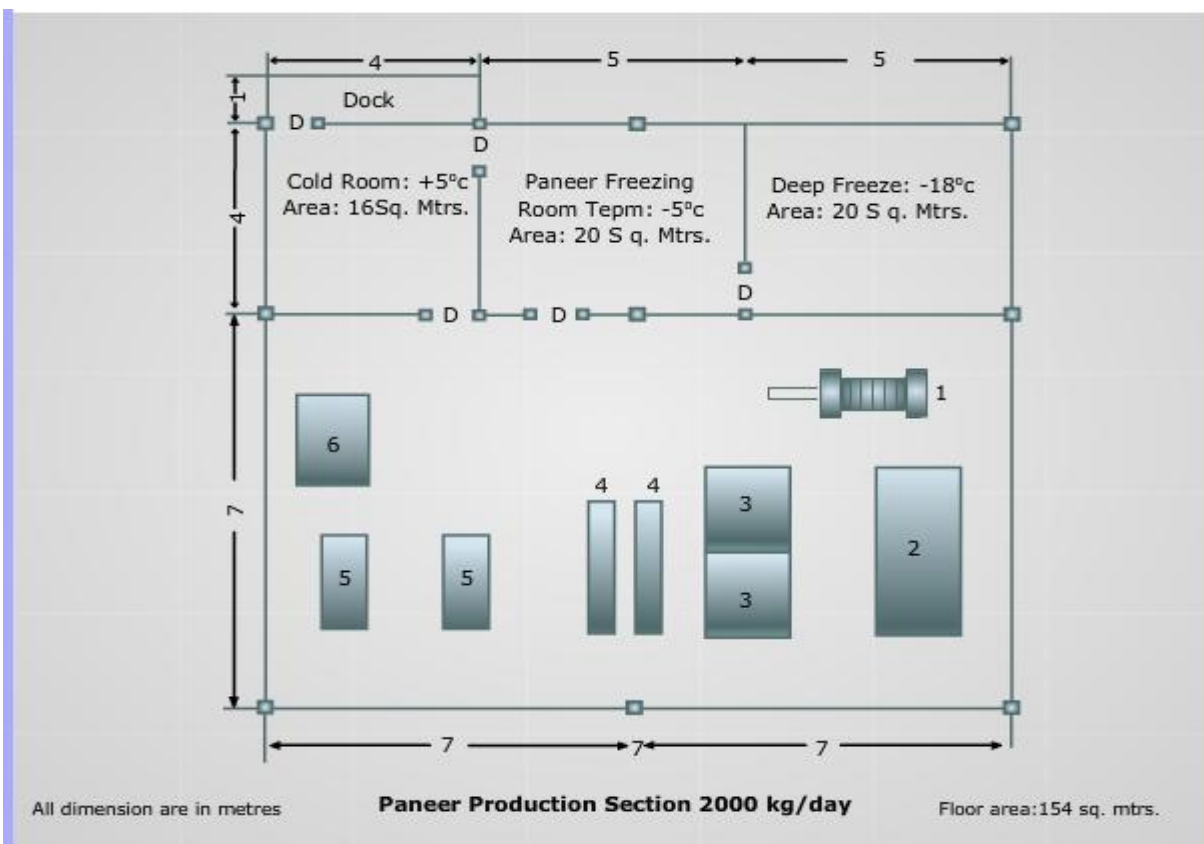

Fig. 16.8 Paneer Production Section

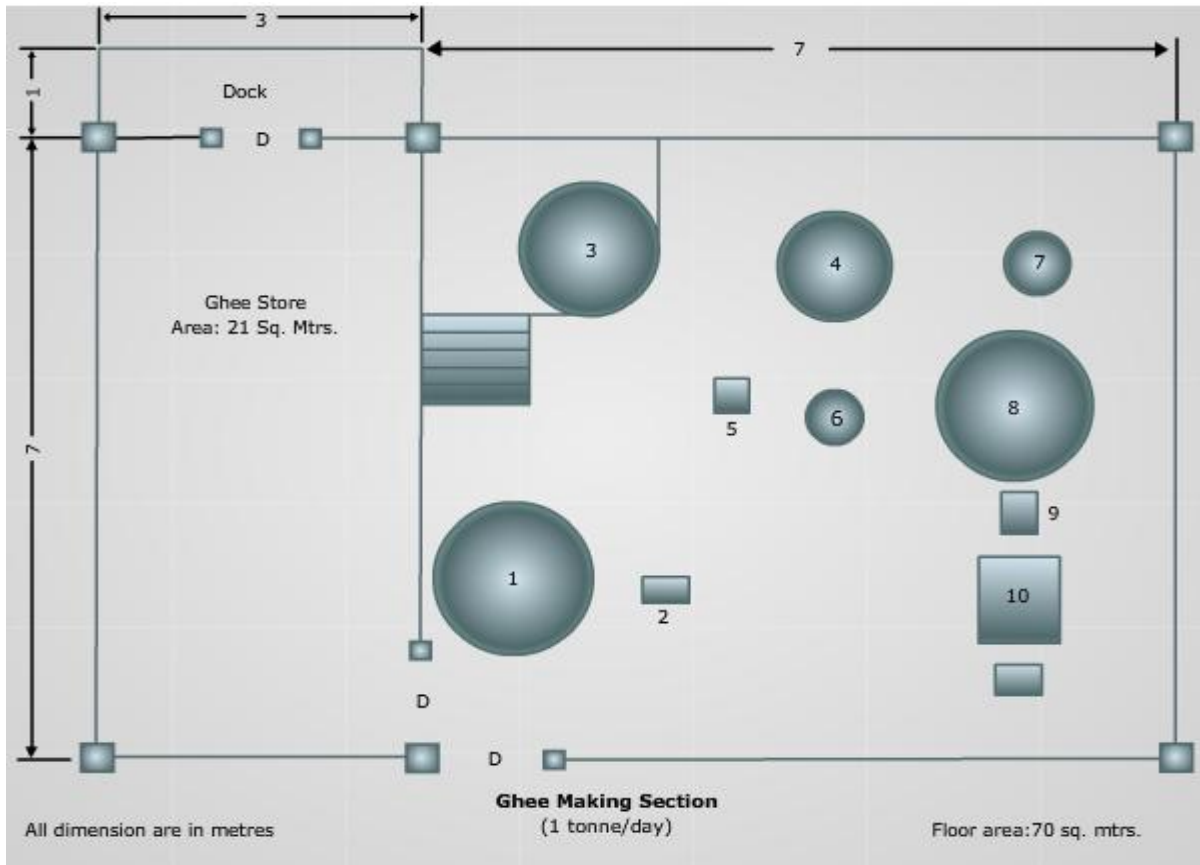

Fig. 16.9 Ghee making section

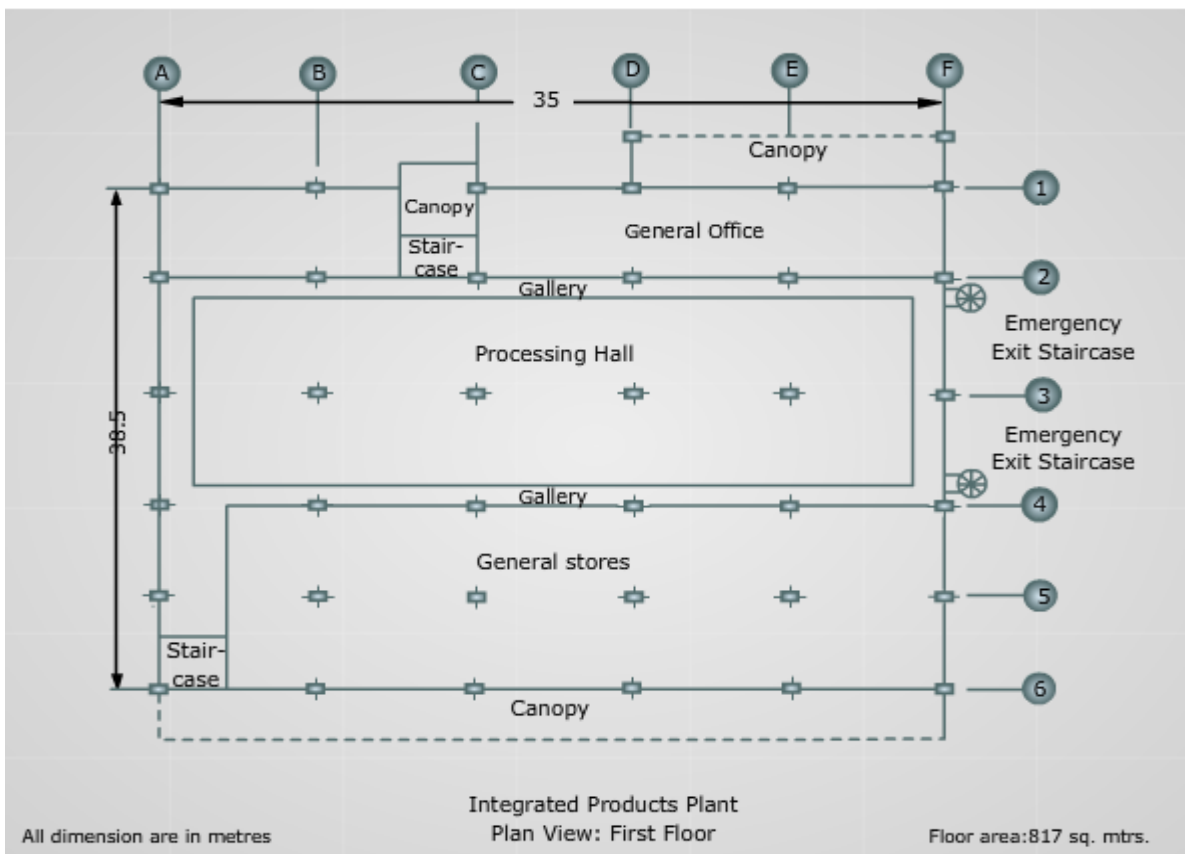

Fig. 16.10 Integrated product plant

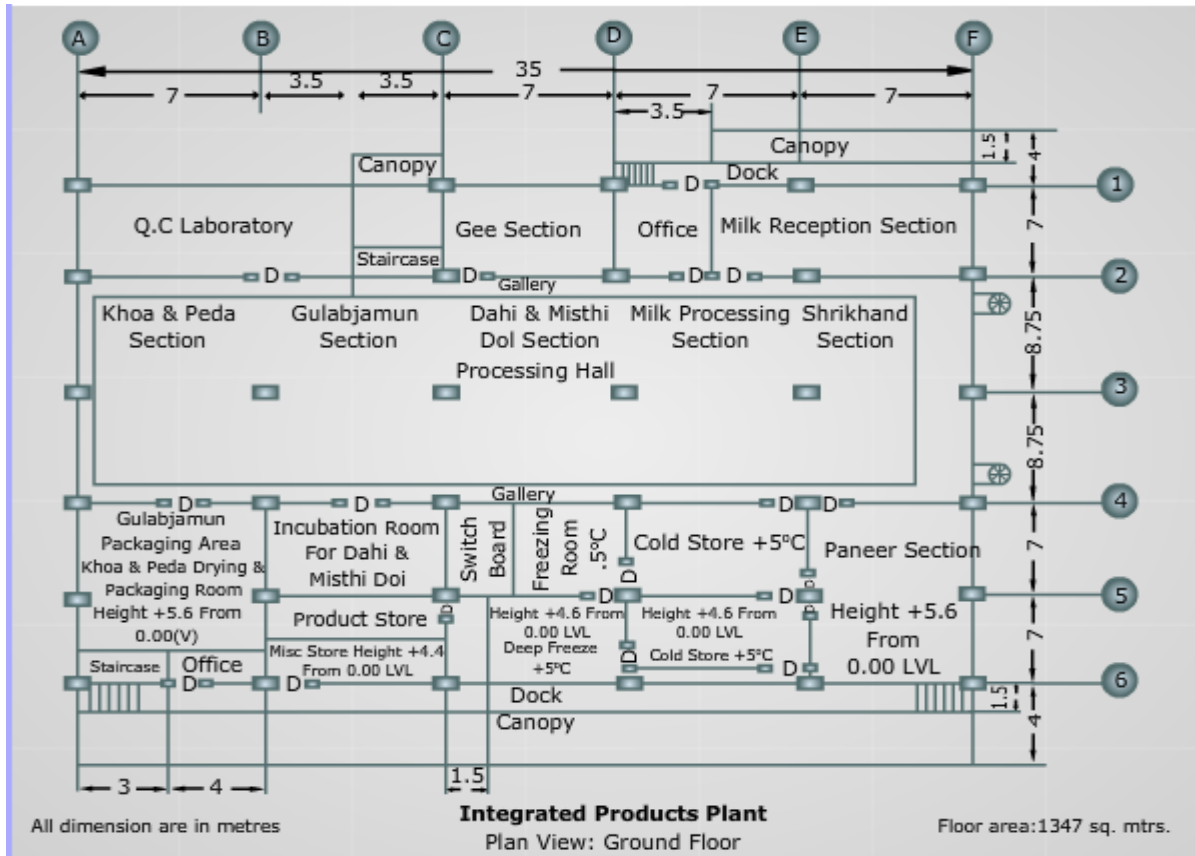

Fig. 16.11 Integrated product plant

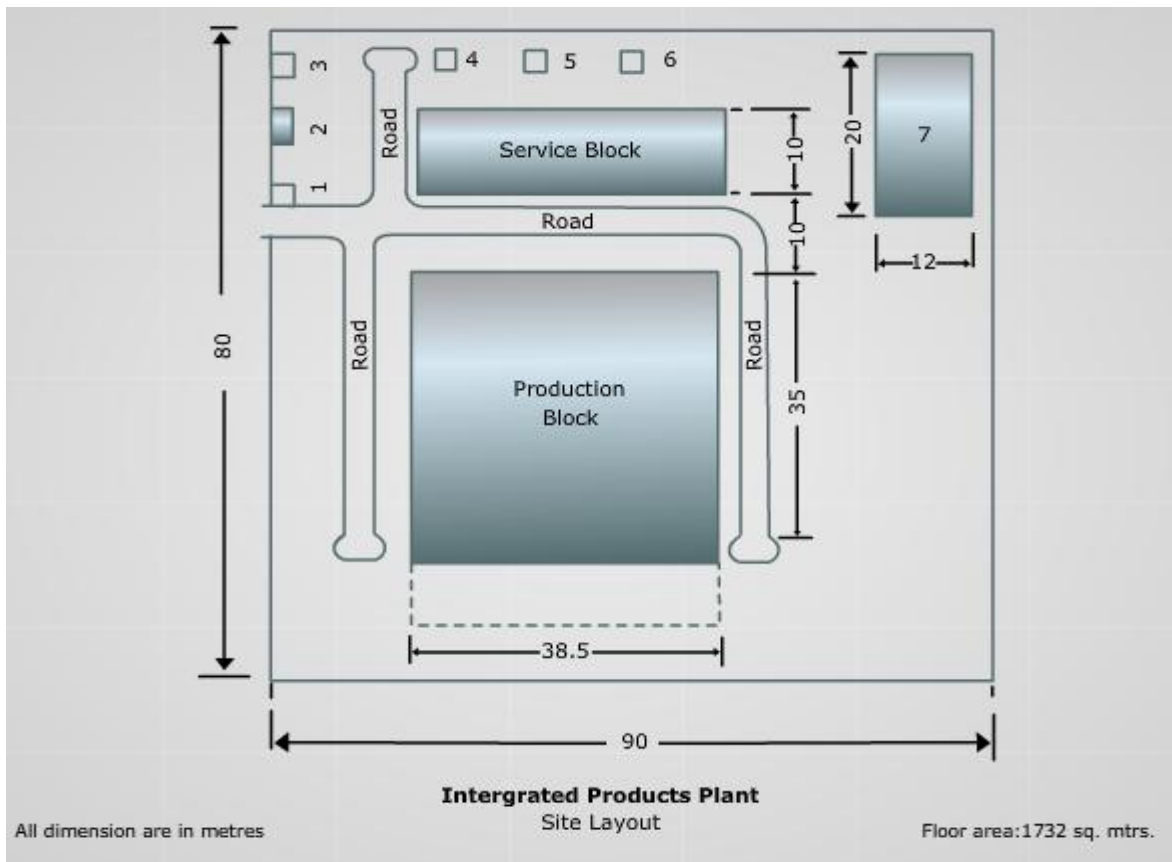

Fig. 16.12 Integrated product plant(Site layout)

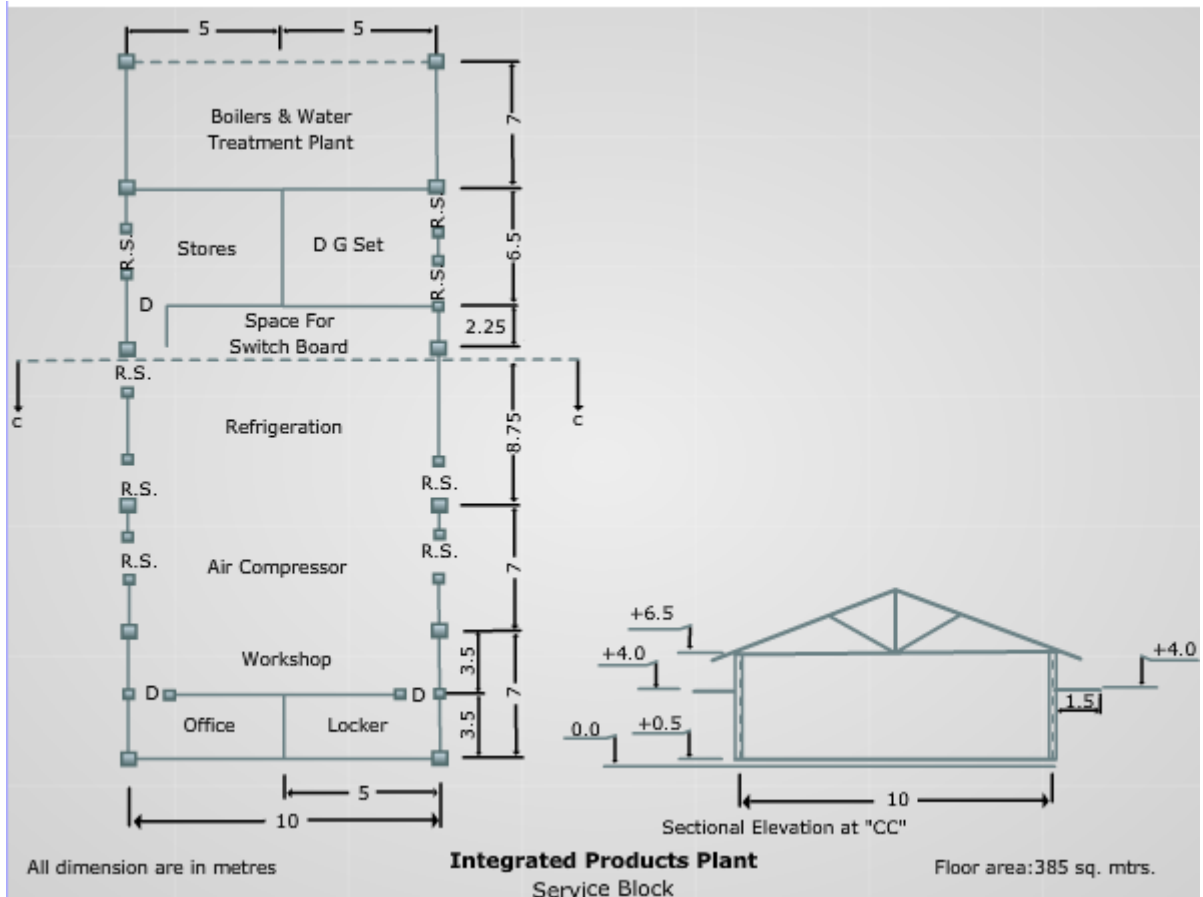

Fig. 16.13 Integrated product plant(Service Block)



Lesson 17

Single or multilevel design

17.1 Introduction:

Single or multi level design of dairy plant is decided based on its capacity, type of products manufactured and provision for future expansion. The single story concept is used where plenty of land is available at cheaper rate, but if land is costly then multi level concept is used. In multi level dairy plant concept of super structure on beams and columns is used to have better strength and to facilitate future expansion. Multi level concept is also used for drying plants. In multi level dairy plants heavy machineries are generally installed at ground level and if required to be installed at other place then it should be provided by pillars up to ground level to transfer vibrations and impact load likely to come on it.

17.2 Selection of single or multi level building

The number of floors to be provided in the building obviously affects the planning of various sections and the area required. In considering this, it should be remembered as a general principle that it is preferable to keep heavy goods at one level and that liquids are easily pumped to high level and can flow back by gravity.

If the depth of the external drainage system, the nature of the site and the condition of the ground are suitable, a basement for the supply and distribution of services should be considered. Such an arrangement allows short, direct connections to the process equipment on the ground floor and eliminates the necessity for housing service pipes in the process room.

For small plants specializing in only one product, and where floor space required is relatively small, it is almost always cheaper to build in one level, this may also be the case for large single product plant. In other cases provided conditions permit, basement to house services will generally be an advantage.

The number of floors above ground which the plant should have depends to some extent on the scale and nature of the process, but mainly on the number of product to be manufactured. However, small plants are generally of single storey even if several products are made. Only the storage tanks are at first floor level.

For medium size plant dealing with one or two products such as bottled milk and butter, it is more practicable to have the main sections on the same level. Only the tank room needs to be placed on an upper floor, partly to reduce length of the piping and also to avoid pumping treated with to the bottled machines. If the plant specializes in more than two products than the floor space required would be so large that it should be more economical to construct a two storey building. Some types of equipment require two storey operation, for example continuous sterilizers and spray driers.

Which sections are to be located on the various floors is a matter of practical business administration and the deciding factors include the extent of production and the transport of goods. It is assumed that the plant has a service basement which can also provide storage for packing materials and other commodities, as well as housing operational equipment.

Lesson 18

Service accommodation

18.1 Introduction

Siting of auxiliary services mean proper placing of service sections providing auxiliary services such as steam, refrigeration and electricity to the dairy plant. In small and medium capacity plant, it is practicable to provide these rooms within the main building. But in large plants, it is better to group these rooms in a separate building. The arrangement of rooms where secondary equipment such as boiler, compressor, evaporators, condensers and workshop equipments are installed should be such, so as to allow easy supervision. Equipment, such as brine pumps, chilled water pumps, hot water circulating units and control should be located in a separate or beneath the floor away from processing section.

18.2 Boiler room

The boiler house, if placed in the main building, it should then be placed near the main areas utilizing steam, such as mil drying and condensing. Usually boiler is installed on the ground floor with access from one side for the removal and replacement of the plant when required. The room for boiler accessories should be close to the boiler house. The discharge of solid fuel and removal of ash are dusty operations. Therefore, it is desirable to place the boiler section in such a way that the process room is not affected by it. This point has to be considered carefully if solid fuel is used.

18.3 Refrigeration machinery room

Refrigeration is a costly affair. Economy should be considered in minimizing the length of service lines by locating it centrally, and near the place where cooling is required. In small and medium capacity plants, the condensing unit for the cold store may be placed adjacent to it; but in large plants or where the products include ice-cream, the equipment involved will require a special room. This should be placed as close to the load areas as possible because in these and other applications of direct refrigeration, the longer the service lines, the greater the cost of refrigerant required to charge the system and greater the running cost.

Indirect refrigeration using chilled water is mainly concerned with precooling of raw milk and final cooling of pasteurized milk. In small and medium sized dairy plants, it is possible to place the compressor and chilled water tank with those for direct refrigeration. In large plant, it is better to site compressor near the section concerned.

An energy exist must be provided in the compressor room. Care for installation or replacement of equipment should be taken in view and this would decide to site the compressor room on ground floor with easy approach to room in case of emergency.

18.4 Electricity

If the electricity is purchased from outside, i.e., State Electricity Board or Municipal Undertaking, then high or low voltage intake will present no unusual siting problems. In case the electricity is to be generated, the power house should then be located close to the boiler house for supervisory reasons. The switch rooms should be centrally located to economise in wiring. A large plant may have more than one switch room.

The siting of switch room may be more difficult to decide especially in a multistory building. If all or most of the motor starters are housed there, power cables must be taken to the equipment concerned and control circuits must be brought in from all the operating stations. Thus, the switch rooms must be located as central as possible to economies in wiring.

18.5 Workshops and garages

Workshops include three main sections which will carry out routine repair and maintenance work of dairy in respect of Civil Engineering, Mechanical Engineering and Electrical Engineering. A small dairy will have one large workshop having three sections under one roof. For medium and large dairies, there will be separate workshops for electrical, mechanical and civil works, respectively. All workshops can be grouped and placed in a separate building near the plant.

Garages are generally of two types, one meant for parking cars tankers or other vehicles, the second one is for repairs. Parking garages are located near offices or place of work. If the plant has its own fleet of vehicles, then garages have to be erected at a suitable place on the site. The garages may be placed close to workshop with facilities for washing the vehicles and for lubrication services.

Residential accommodation for key workers or essential service personnel may be constructed near the plant side but quite separate from plant building.



Lesson 19

Arrangement of different sections

19.1 Introduction:

Arrangement of different sections of dairy means siting of various sections in relation to each other in dairy building. Arrangement of different sections in dairy must be done in such a manner that main rooms are planned and sited in relation to each other first. The product sections can then be grouped around them. Utility sections are placed near the areas where services are needed. Garages with facilities for washing and lubrication will be placed adjacent to workshop. Offices will have separate apartments. Overall layout of the dairy plant should be of functional design and should give hygienic outlook. Arrangement of different sections in the dairy plant has effect on energy conservation and product losses. Arrangement of different sections should be based on the future expansion required in the dairy plant.

19.2 Arrangement of primary and secondary rooms

Primary rooms mean milk reception and milk treatment (milk processing) rooms. Reception and milk treatment rooms should be connected with each other. The laboratory is mainly mean for testing incoming milk and should, therefore, be located adjacent to milk reception dock. Cold store should be placed adjacent to bottle/pouch filling room. Secondary rooms mean rooms not directly connected with milk, e.g., dry stores accessory room etc. Secondary rooms are attached to their main requirement sections. For instance, boiler accessories room will be sited adjacent to boiler room.

19.3 Arrangement concept of various sections of dairy in general

An arrangement concept of various sections of dairying in general Fig. 19.1. It will be noticed that product sections are placed around milk storage and treatment room (main rooms). Product storage is next to product sections from where they are sent to dispatch dock. Laboratory has been placed near milk reception and refrigeration machinery room near the product storage. Utility sections near the area where services are needed. This is only a concept diagram.

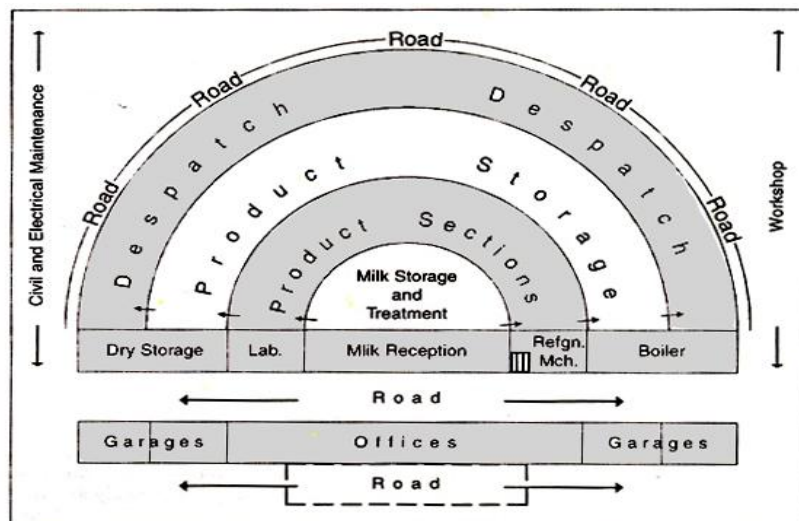

Fig. 19.1 Arrangement concept of various sections of dairy in general

19.4 Planning and arrangement of small milk plant

Small plants are usually on ground floor, i.e., one level and arrangement should be like Fig.19.2. for a small plant for market milk. The milk storage tanks can conveniently be placed in milk processing room because hardly one or two items are manufactured in small capacity units. Laboratory is connected with milk reception room. Next to storage is placed dispatch dock. Service sections and office areas have not been shown in this block diagram.

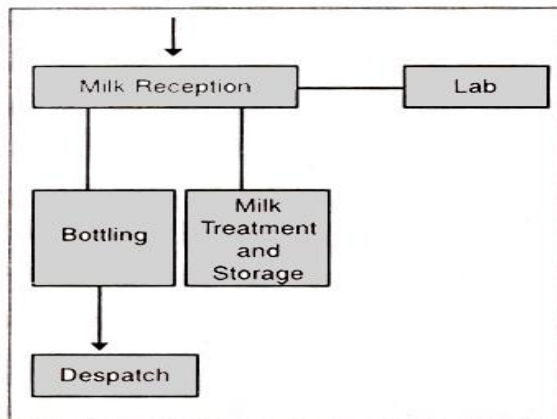

Fig. 19.2 Room arrangement of small milk plant

Where the market milk is to be standardized, the plant may incorporate a butter section to utilize cream. This butter section can be arranged as shown in Fig. 19.3 in such a way that the cold rooms for butter and bottled milk are next to each other. By doing this, there is saving in respect of thermal insulation and cooling capacity. Also the products loading are then done through the same bay. In this room arrangement for market milk and butter making plant cold stores can be placed just before dispatch dock. This is the arrangement of processing sections only. Other sections can be linked suitably to complete the dairy unit.

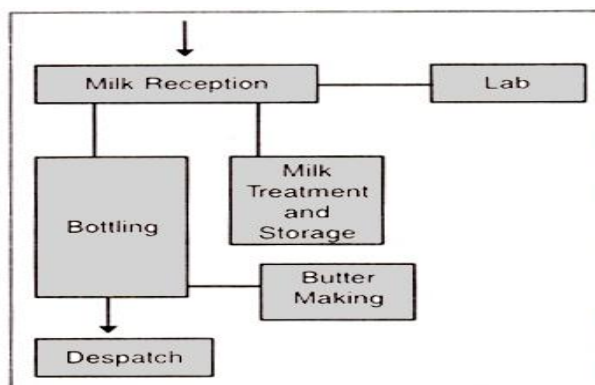

Fig. 19.3 Room arrangement of small milk plant for market milk and butter

In all cases while arranging the rooms, flow of the product should be kept in view, and all pipe lines should be as short as possible so that economy is achieved. Flow should be in order and accordingly the placement of the rooms. Future extension cannot be neglected. So while sitting the rooms, at least one wall should be made in such a manner so as to allow for future extension in one or the other direction.

19.5 Medium-sized dairy plant

Medium-sized dairy plant ranging capacity from 20,000 liters to 80,000 litres of milk handling per day will require that each room should be planned separately and then all rooms be arranged as per requirement with forward flow of product in view. The market milk section may include milk in glass bottles, in 20 or 40 litre cans, polyethylene or tetra packs or paper cartons and other non-returnable containers. A bottling section should be planned as shown in Fig. 19.4. From this type of set up it will be noticed that empty bottle side and dispatch side are free so that trucks can drive up to dirty bottle reception dock (empty bottle side) and dispatch dock easily and thus there will be no rush of vehicles. This separation of dairy bottle reception dock and despatch dock is essential in medium and large size dairy plants. Left side has been kept free for future extension. If non-returnable containers are used, this will completely dispense the bottling line. This means, there will be saving in floor space. Basement if available can be used for storage purposes.

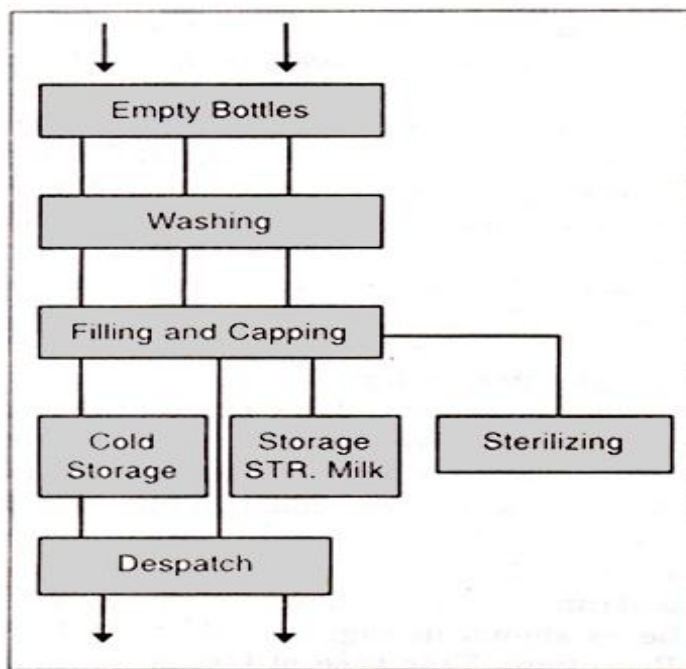

Fig. 19.4 Basic Plan for milk bottling section

Medium size butter sections are often simple to plan and place. The various space required within the section for production of butter are laid out as shown in Fig. 19.5. This is only a concept. Other sections are suitably linked and placed within main building. Tanks for the storage and treatment of cream are often placed in butter making room when one person is there to supervise the section. Where butter is discharged from the churn or other butter making equipment directly to the packaging machine by a chute, the rooms must be on two levels. Cold store for butter should be placed near dispatch dock, if possible.

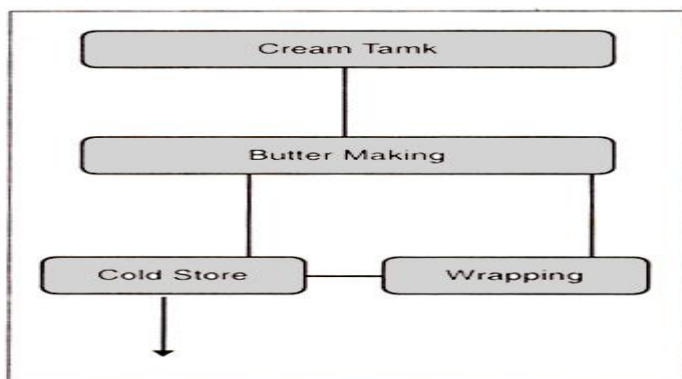

Fig. 19.5 Space layout within room for butter making

Layout of cheese section which includes cottage cheese will require cold store and daily distribution. For this, cold store would be placed close to milk store as shown in Fig. 19.6.

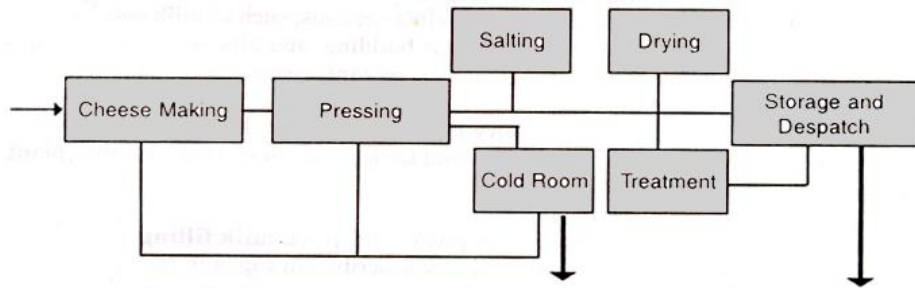

Fig. 19.6 Cheese section for several varieties

The processing of cheese will involve cheese making, pressing, treatment and storage. Cheese rooms vary in number, size temperature, humidity etc. For different types of cheese placing of one after the other on one level would naturally make the area of the building very large, particularly in those cases where the cheese has to be stored for a considerable length of time, thus requiring very large storage rooms. In large cheese making plants, it is advisable to have a vertical arrangement if possible from production and technical standpoints. For certain types of cheese, curd can be produced on an upper floor, and then conveyed to the room below, where pressing and other processing take place. From here, the cheese can be conveyed horizontally or down to the basement where it can be stored or further treated. Where space is available, curdling, pressing and other processing are carried out on one level with storage rooms underneath. When very large storage rooms are needed, these must be sited on a suitable number of floors by the side of cheese making premises.

19.6 Large-sized dairy

For large-sized dairy plants, the best solution is to have both milk treatment and tank storage on the first floor. The actual design depends very much on planning of reception room. If there are more than two weighing-in units with necessary conveyors and can washers, the layout suggested may be as shown in Fig. 19.7 (Multiple Line Reception). This type of layout makes a rectangular form of the milk reception room, thus making it easier to place within the structure of the building.

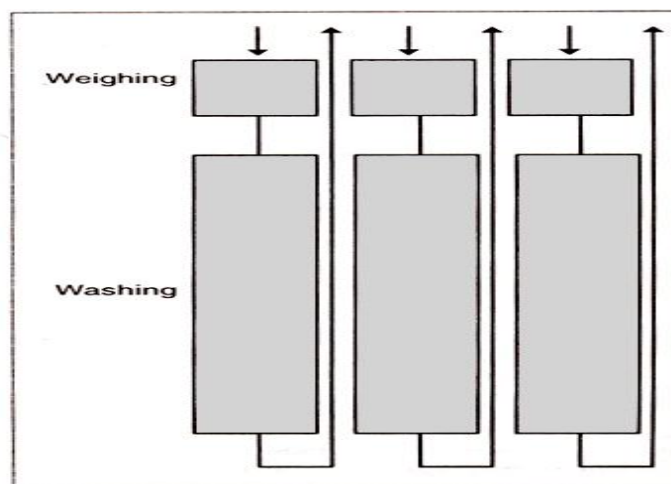

Fig. 19.7 Multiple line reception layout

In a multiproduct plant, the suggested layout of rooms may be as shown in Fig. 19.8. In this case when product sections are grouped around primary rooms, there will be difficulty in future extension of primary rooms. In

such situation, it is advisable to have primary rooms sufficiently large enough in the beginning, so that, when question of future extension is there, it is only in respect of capacity of the equipment. If any of the product sections, such as milk powder section is very large, this can be housed in a separate building, and pipelines connection can then be taken overhead. Such arrangement is advantageous if extensive changes in operation are expected in the future.

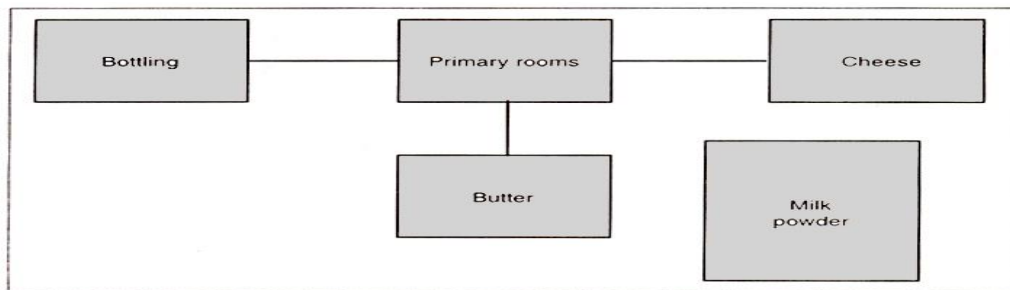

Fig. 19.8 Multiple product plant layout

In a nutshell, the principles of dairy layout should be following, various working sections be placed around milk treatment and tank room, no matters whether plant is built on one, two or more levels.

19.7 Arrangement of bottling section, pre-pack/tetra pack milk filling

Arrangement of bottling section is clearly described in Fig. 19.9. In this case, dirty bottle reception and dispatch of milk is on the same side. In this arrangement, comeback type bottle washer has been used. Bottles after filling find straight route for dispatch through cold store as dispatch dock ((not shown) is next to cold store). This arrangement is available for small dairies. Bottle washer and crate washer can be placed in a separate room while milk filling machine in the processing room near cold store.

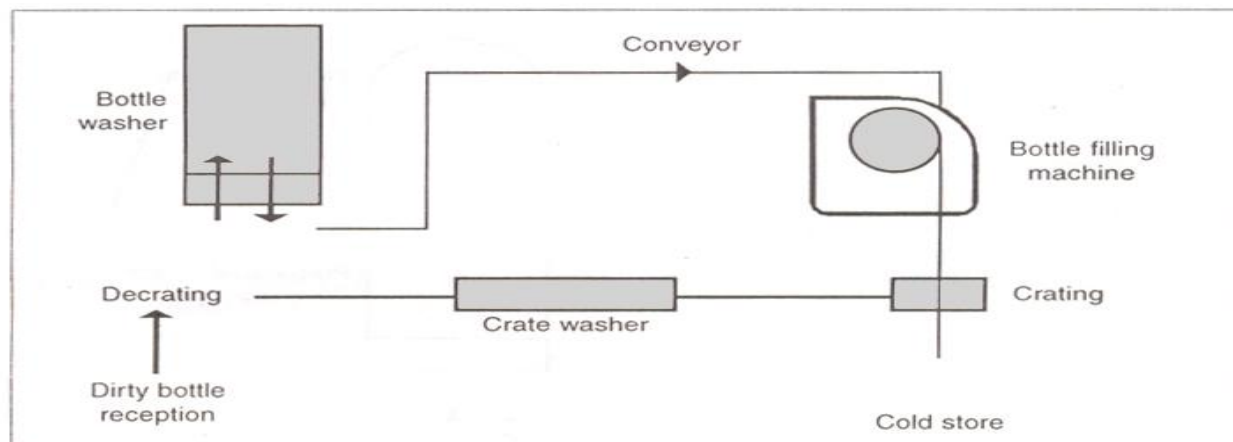

Fig 19.9 Arrangement of bottling section using come back type washer

An alternate arrangement (Fig.19.10) where crates travel straight and position of dirty bottle reception dock and dispatch dock are just opposite to each other (docks are not shown in the diagram). This arrangement utilizes straight through bottle washer.

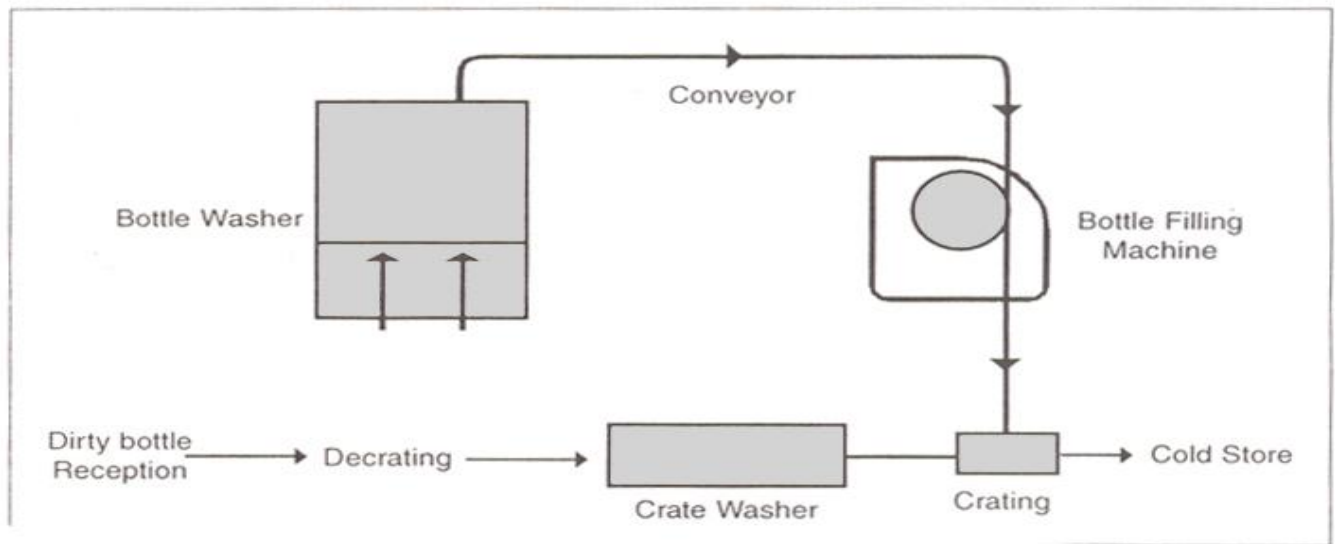

Fig. 19.10 Arrangement of bottling section using straight through bottle washer

The arrangement of Pre-pack/Tetra pack filling machine (Fig.19.11) where crate handling is done by hand trolleys. Here passage is not blocked by conveyors. Cold store is on the right side of the crate reception.

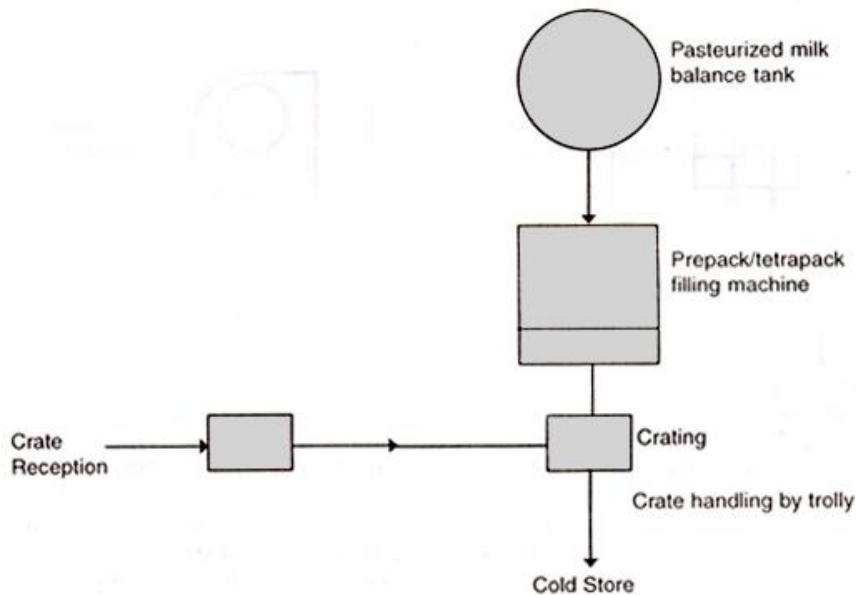

Fig.19.11 Arrangement of Pre-pack/Tetra pack filling machine

The crates carrying milk pouches (Fig.19.12) travel straight to cold store. This arrangement using conveyor saves labor and is efficient and economical though initial expenses are more. This has to be planned in relation to other sections, in such a way that passage is not blocked for carrying out other operations.

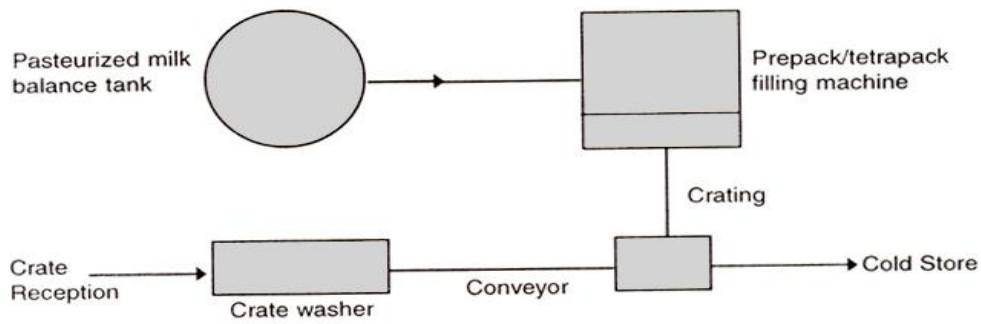

Fig. 19.12 Arrangement of prepack / tetrapack filling machine crate handling by conveyer

19.8 Layout and arrangement of milk treatment, processing and product rooms

In large dairy planning for milk treatment, processing and products rooms has to be done carefully. For large dairy, primary rooms, i.e., milk reception, milk storage (tank room), treatment room (processing room) have to be centrally located. These rooms are planned and sited first in relation to Reception Dock and Milk Testing Laboratory. Product sections when grouped around them will have easy approach. These sections may be interconnected, but they must have direct approach to milk processing room. Butter section may be connected with ghee making section. It is advantageous to interconnect similar nature product which may have same bay for dispatch. If stores and cold stores are planned on one and the same side of the dairy building, the loading of end product can be done easily. This will save unnecessary travel of men and material. Plant will be efficient if material handling is minimized. The route should be as short as possible.

19.9 Service sections

Siting of auxiliary services mean proper placing of service sections providing auxiliary services such as steam, refrigeration and electricity to the dairy plant. In small and medium capacity plant, it is practicable to provide these rooms within the main building. But in large plants, it is better to group these rooms in a separate building. The arrangement of rooms where secondary equipment such as boiler, compressor, evaporators, condensers and workshop equipments are installed should be such, so as to allow easy supervision. Equipment, such as brine pumps, chilled water pumps, hot water circulating units and control should be located in a separate or beneath the floor away from processing section.

19.10 Office layouts and their linking with dairy plants

A dairy factory will not have only technical, dairy professionals, operators, skilled and unskilled workers, but will also have staff personnel not directly concerned with plant, but very much associated with dairy. This staff looks after all activities of dairy such as administration, milk procurement, processing, dispatch, distribution, sales and marketing of products, establishment, finance and accounts, H.R.D., security (watch and ward) and management in general.

This staff requires office accommodation comprising number of rooms properly linked. For employee comforts and convenience, staff canteen, toilets, reception lounge have also to be provided. Size of office varies with the capacity of the plant. A small dairy may have small office as number of activities will be less. Medium size dairy plant will have bigger office as compared with small dairy. In this number of activities will be more and plant may be manufacturing more products. Accordingly, staff will increase. A large dairy will still have large

office with large number of staff employed. Before deciding number of rooms in office and space requirement, it is essential to know the activities, number of departments and persons who can handle the work, as number of persons employed will determine the area and room needed by them.

A small dairy may have sections or departments viz milk procurement, milk processing, milk dispatch and distribution, sales and marketing, advertising, sanitary control and hygiene, security (watch and ward), establishment, finance and accounts, dairy technology and dairy engineering.

Medium dairy will have all above departments, but there may be addition of two or more sections, such as labor welfare department (office), human resource development (H.R.D. section), personnel department etc. Large number of employee and labor justifies the existence and importance of additional sections mentioned above.

In small dairy office, there will be one Manager who will be assisted by various Sectional Heads with suitable designations. Each Sectional In charge will have 2 or 3 Assistants/Clerks and one Peon or Attendant. All staff will be housed in a separate building or block which will be suitably linked with dairy, except for security office which will be located near the entrance or gate of the factory. Officer Incharge of a particular section will have his room next to his working section for easy approach and supervisory reasons. For instance, Accounts Officers' room will be immediately next to Accounts Department or Section.

Medium-sized dairy plant may have one General Manager, one Deputy General Manager, one Manager, three Deputy Managers, six Assistant Managers, twelve Sectional Heads with suitable designations and three Assistants or Clerks with two Peons or Attendants in each section.

Accommodation for all these staff members has to be provided and carefully planned keeping logic in mind. Sufficient space has to be provided for walk ways, passages, corridors and reception lounge with visitor's waiting room.

Large dairy plant will have big office layout with large number of employees at different levels to manage various department. Staff pattern in large dairy organizations is somewhat different from other two small and medium size dairy plants. Here above General Manager, there is Managing Director, Board of Directors presided over by Chairman of the company. While deciding accommodation and room layout for office of this magnitude, it is essential to make provision for Chairman's office, Board Room (Conference Room), Guest Room / Guest House etc. It is a good practice to work out detail staff required at all levels in the factory including office and plant works. The organization chart may be drawn, which will give clear picture of staff position. Accordingly, office layout can be prepared. Refer Part B of the book chapter titled 'Office Layouts'.

19.11 Missing-view problems

Missing view problems on room arrangement for different sections of dairy building are given in Figs. 19.13 and 19.14. It is required to study the layouts carefully and then add missing sections linking them logically, keeping in view planning and principles of dairy layout. Utility sections, offices, workshops and garages etc. are not shown in these diagrams. These missing sections are to be linked suitably in such a manner that a complete room arrangement layout of dairy is presented. Reception and dispatch docks can also be shown in the layout alongwith approaching roads around the plant. Fig. 4.13 shows small dairy plant manufacturing three products, namely Milk (in bottles), Butter and Cheese. Fig. 19.14 shows layout of condensing and drying section of medium size dairy plant. Fig. 19.15 shows arrangement concept of various sections in dairy in general, while Fig. 19.16 shows arrangement of various sections of dairy in general

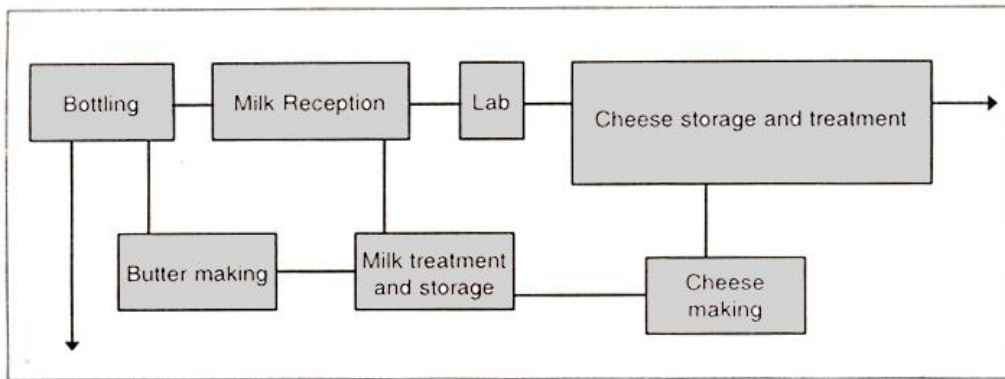

Fig. 19.13 Small plant for three products

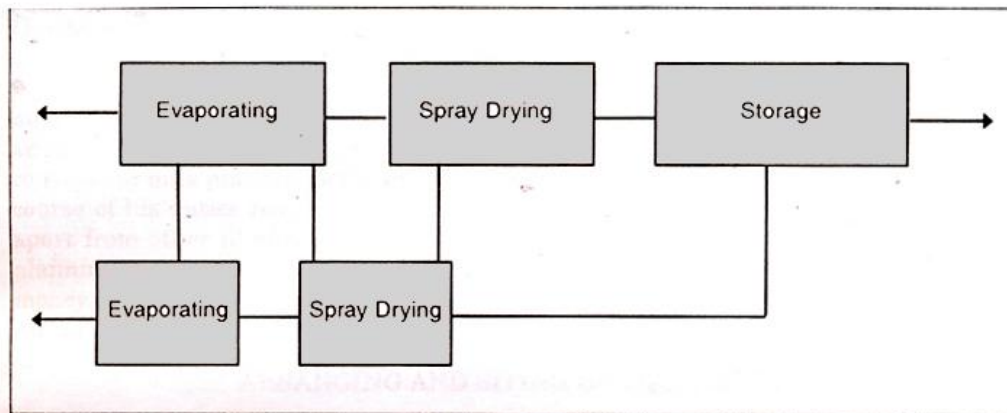

Fig. 19.14 Condensing & drying section

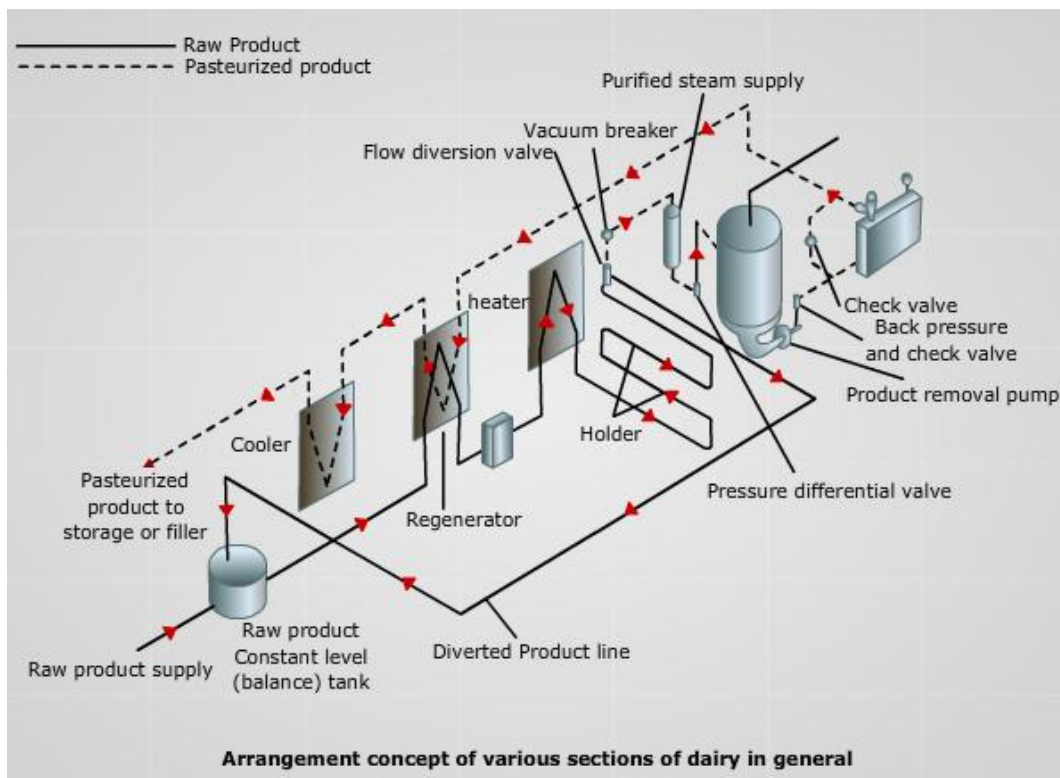

Fig. 19.15 Arrangement concept of various sections of dairy in general

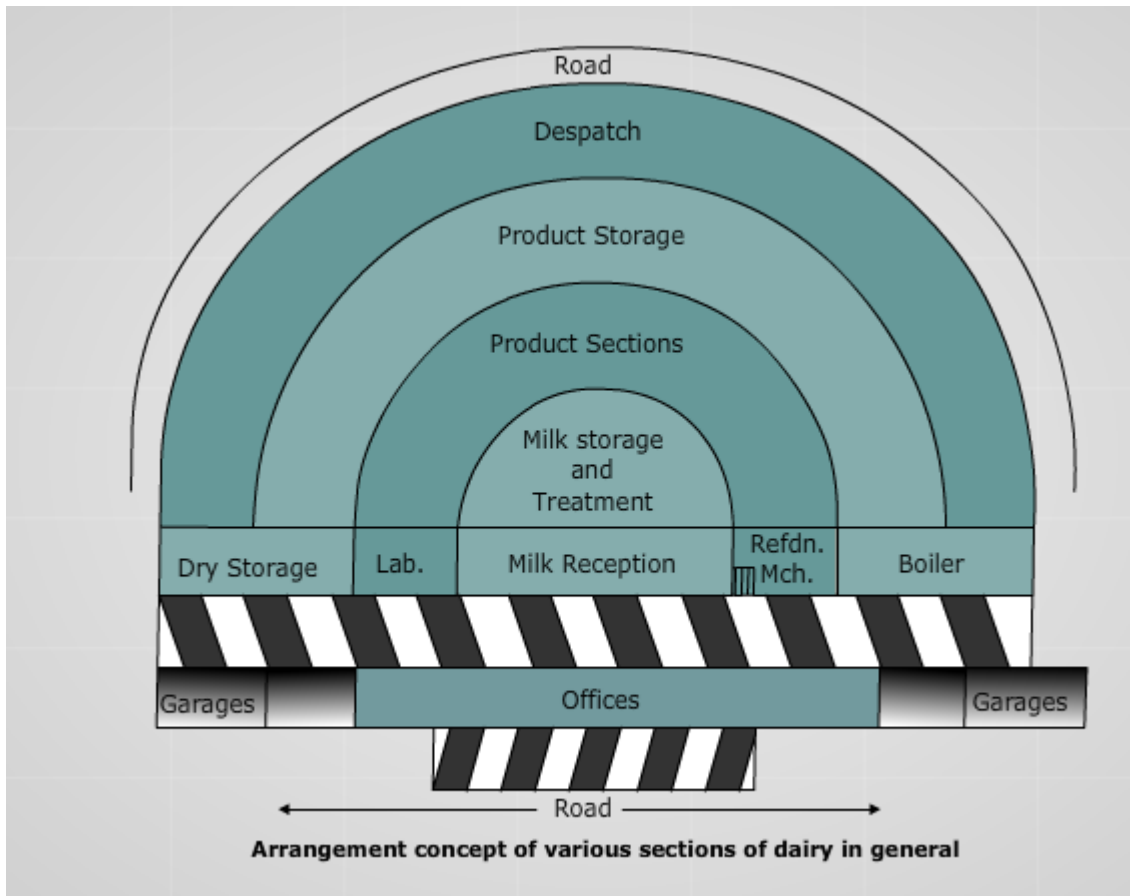

Fig. 19.16 Arrangement of various sections of dairy in general

***** 😊 *****

Lesson 20 Service pipe-line layout

20.1 Introduction :

Service pipe line layout for different services required in the dairy plant like steam, well water, chilled water, hot water, fresh water, refrigeration, air etc. is prepared for minimizing material requirement, estimating cost of installation, to facilitate selection of different fittings, and to smoothen the operation. Service pipeline layout is prepared considering safety aspects of the plant and personnel working. It also helps in deciding the material requirement, mountings and accessories required in each pipelines. There are different color codes used for different piping systems. The steam pipe is painted with yellow color, chilled water pipe line is painted with blue color, well water pipeline is painted with green color and pipelines carrying hot fluid are painted with red color. The pipe lines carrying hot and cold fluids are insulated with suitable insulating material.

20.2 Color coding for identification of pipe-lines

When a number of pipe lines are running in dairy factory, it becomes necessary to know what material is being piped through particular pipe. To avoid any sort of accident, it is important to identify the pipe lines. The American Society of Mechanical Engineers has suggested color code for identification of all piping arrangement and systems.

Colour codes which have been accepted universally by dairy industry are as follows:

1	Safe products (air, water, etc)	Green
2	Dangerous material (ammonia, fuel oils, high pressure steam etc.	Yellow
3	Protective material piped through the plant to minimize hazards of dangerous material	Blue
4	Fire control equipment	Red

In a milk plant, green color for safe material, yellow for dangerous material and red for fire control equipment are used. However, an organization can use shades of these colors for further identification of more pipe lines. For instance, cold water light green, hot water dark green, chilled light blue etc. A factory using color code for identification of piping must display at the entrance or at a suitable place a color identification of pipes running in the plant. This can be done by cutting small length of pipes say 4 inches and painting them; write the material being piped through against the color painted pipe ends. These may be mounted on a board and hanged on wall so that this can be noticed by all.

20.3 Milk piping

The layout of interconnecting milk piping system should be decided keeping in view the method of cleaning. There are two methods which are commonly adopted for cleaning milk piping. These are: (1) manual cleaning method and (2) cleaning-in-place (C.I.P.) method.

If manual cleaning method is adopted, it must be clear that the pipes have to be dismantled frequently for cleaning operations and for this purpose, it is essential that approach to pipe lines is made very easy, i.e., piping system is easily accessible. For this piping supports from ground (floor) is preferred for supporting overhead pipe lines which are 7 to 8 ft above the ground level. Piping supports should be placed at a distance of about 3 meters or about 10 ft. All pipes carrying milk are of stainless steel as they are easy to clean. Sanitary piping is recommended for dairy industry.

For cleaning-in-place method, approach to pipe line is less important as piping will be dismantled relatively infrequently. Layout of piping in C.I.P. system has to be planned carefully because the purpose is not only conveying or carrying milk but also cleaning. Contamination has to be avoided in all cases. In large installations, it will be necessary to arrange for part of the pipe system to be cleaned while another part is conveying milk, and precautions and safeguards must be incorporated to prevent accidental contamination of milk by cleaning solutions or detergents. A milk piping must be so arranged to minimize loss of product at the end of process run to ensure that all cleaning solutions are removed from plant before use. For C.I.P. cleaning of pipe lines, milk piping may be supported from ceiling. In this metal suspension rods are fixed to ceiling. This gives a clear floor area with no obstruction and operations are carried out smoothly.

Typical layouts for service pipe lines are shown in the Fig. 20.1 (a), 20.1 (b), 20.2, 20.3, 20.4, 20.5, 20.6, and 20.7. figures

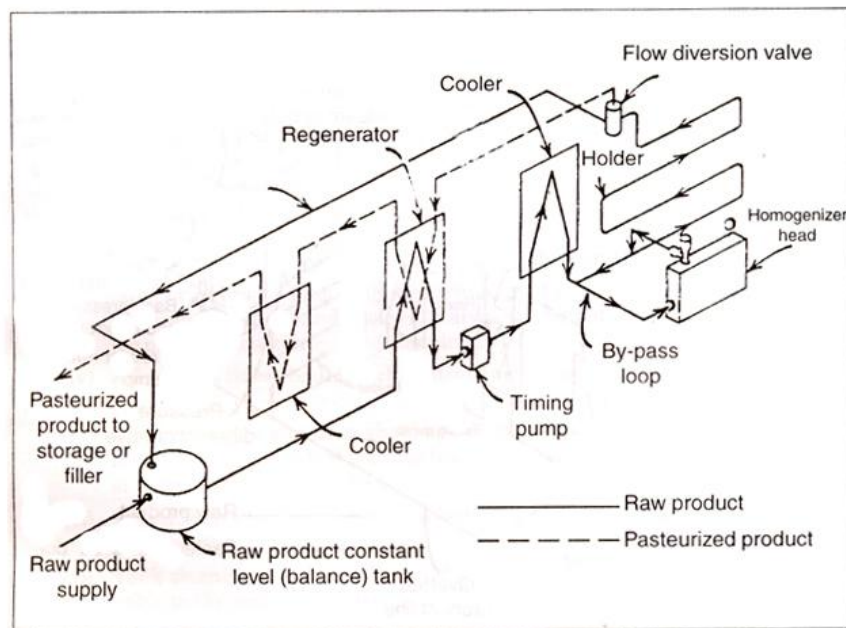

Fig. 20.1(a) Milk piping

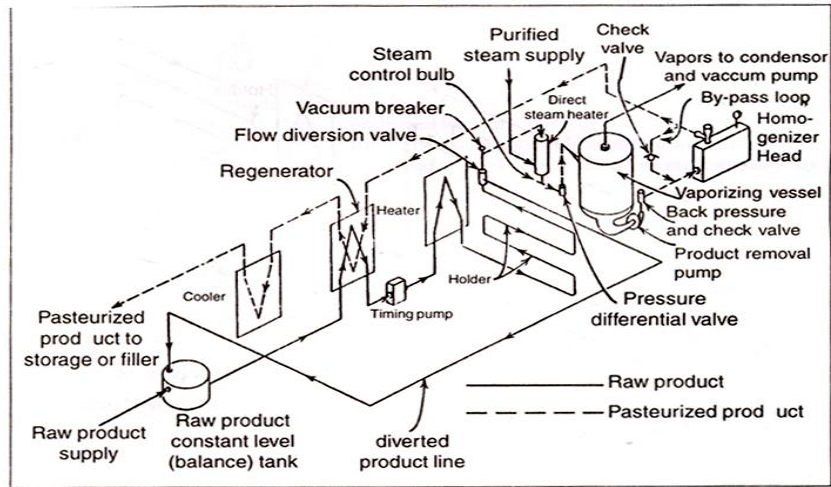

Fig. 20.1(b) Milk piping

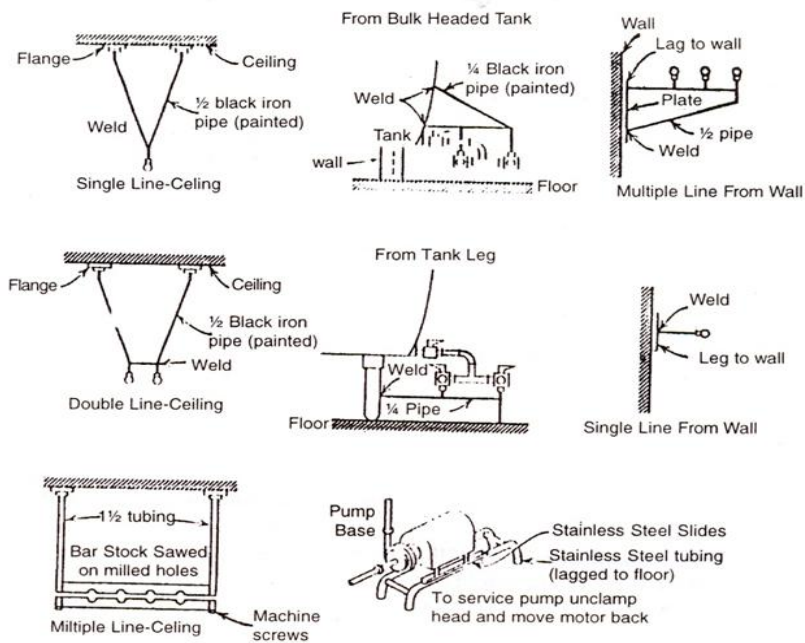
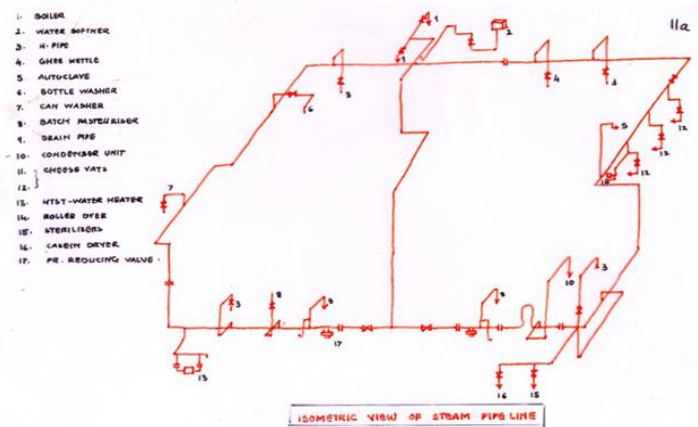

Fig. 20.2 Typical sanitary pipe supports



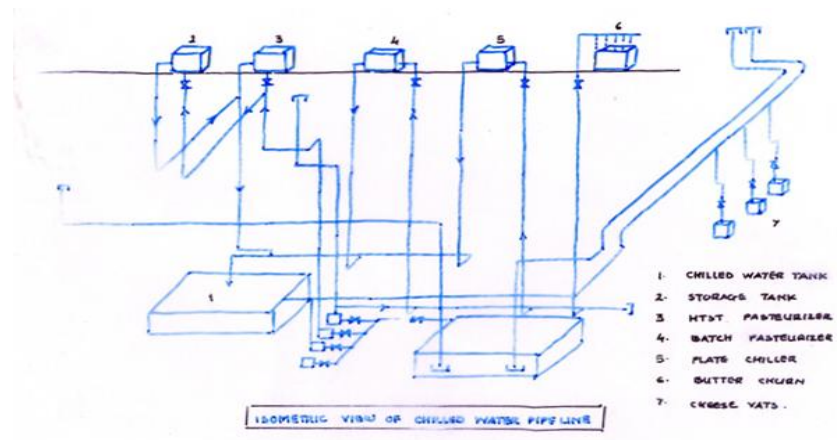

Fig. 20.4 Isometric view of chilled water pipe line in dairy

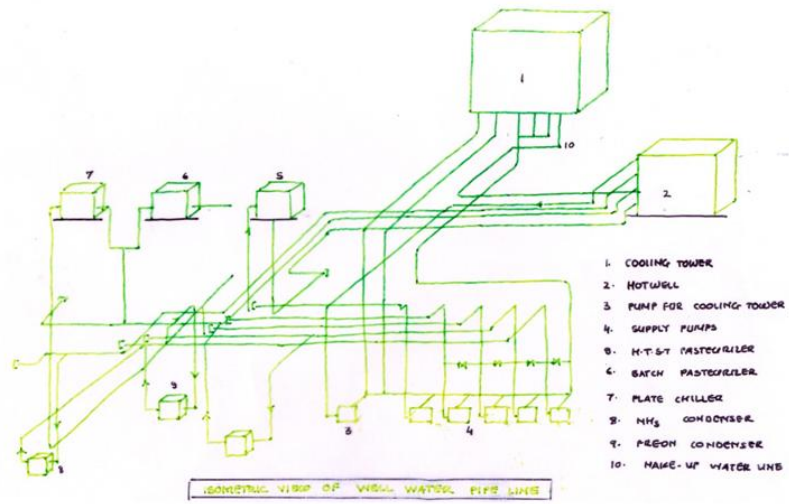

Fig. 20.5 Isometric view of well water pipe line in dairy

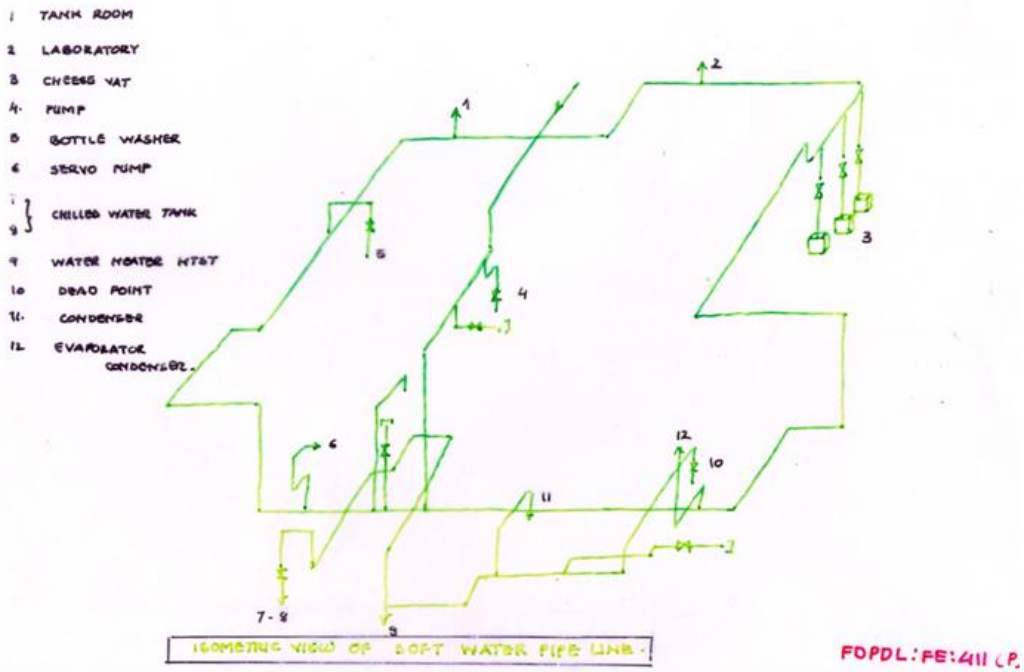

Fig. 20.6 Isometric view of soft water pipe line in dairy

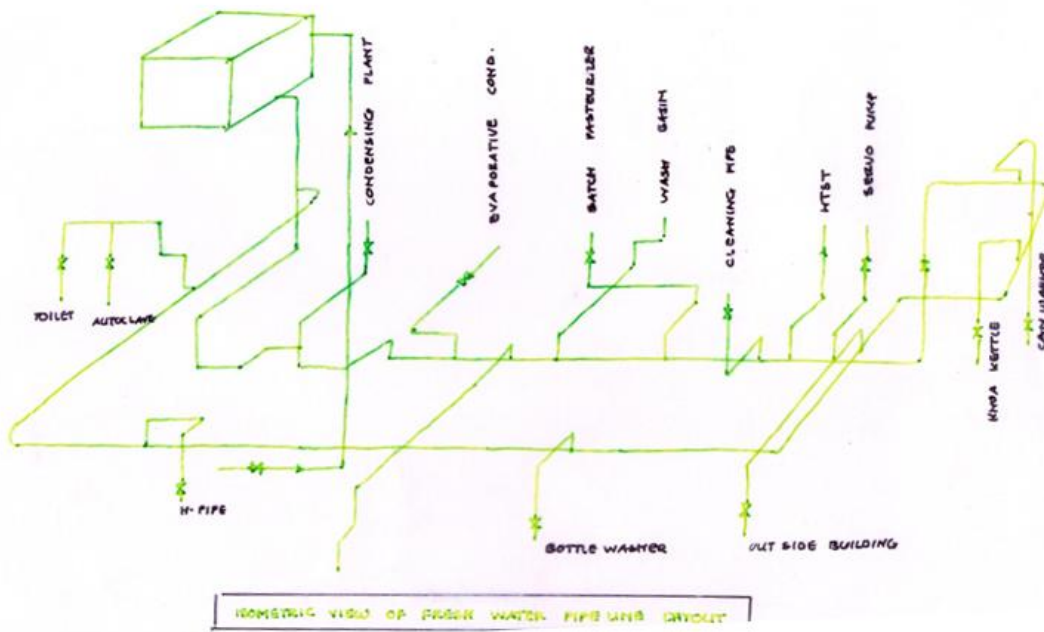

Fig. 20.7 Isometric view of fresh water pipe line in dairy

Lesson 21

Equipment layout

21.1 Introduction

A plant will be efficient only if equipment installation is in proper order. Proper order means laying of equipment according to flow pattern of manufacturing process. The equipment must be laid as per sequence of the operations, i.e., 'what comes next'. Horse has to be put before the cart and not a cart before the horse. For instance, milk after its reception at Milk Reception Dock, has to be weighed, dumped into dump tank, chilled through surface cooler or plat chiller before it is stored into storage tank for further processing. Here a chiller will have to be placed in between dump tank or milk receiving vat and storage tank. Milk route has to be made as short as possible. Unnecessary travel of men and material should be avoided as it amounts to waste of time. Failure to provide adequate working space may hamper cleaning operations or may cause one operator to obstruct to another, thus causing delay. The positioning of a milk cock or other control just out of normal reach may involve an extra journey or additional effort in getting the means to perform the operation involved. Placing a conveyor or milk pipe across the route which an operator will have to take in the normal course of his duties may cause obvious difficulties and may lead to accidents which, apart from other ill effects, reduce operating efficiency. It is often seen that wrong planning and faulty installation of equipment leads to inefficiency, delays and loss of money as plant becomes uneconomical. Therefore, proper arrangement of equipment is essential for any successful plant.

21.2 Secondary equipment

Secondary equipment are those equipment which are not directly related to milk such as boilers, compressors, condensers and workshop equipment. This equipment should be in a separate room from the main part of the dairy plant. Equipment, such as brine pumps, chilled water pumps and hot-water circulating units and controls should be located in a separate room or beneath the floor away from processing section.

21.3 Bulk milk receiving

A minimum clearance of 5 ft (152 cm) above the highest milk tanker should be allowed for cleaning spray head and balancer. An 8 ft (244 cm) working space should be provided behind each tanker for ease in handling the hose and making connections. The floor at rear of the truck should slope $\frac{3}{4}$ " per ft (1.9cm/30cm) for fast drainage.

21.4 Arrangement of processing equipment

The main idea for proper arranging the equipment is to achieve maximum efficiency and economy in respect of installation of the equipment and to provide facilities to staff looking after the equipment for smooth running of the plant. For planning a layout of the equipment, use of layout planning table and model planning is highly recommended. Consideration must be given to the cleaning-in-place system (C.I.P.) when placing the equipment. Storage tanks should be in a battery such as in a row, so that, a common supply and cleaning solution return line can be in a battery such as in a row, so that, a common supply and cleaning solution return line can be used for all tanks. The same idea holds true for the arrangement of pasteurizing vats or similar pieces of equipment. Regular order of the equipment installation is essential and must be in accordance with flow pattern of the product.

A pasteurizer would probably comprise the heat exchanger, hot water set, milk pump, float tank and possibly an instrument panel together with the inter connecting milk piping.

A bottling line would consist of a bottle washer, filler, capper, and associated conveyors. These equipment should be installed in regular order without any obstruction in the way.

21.5 Milk piping

The layout of interconnecting milk piping system should be decided keeping in view the method of cleaning. There are two methods which are commonly adopted for cleaning milk piping. These are: (1) manual cleaning method and (2) cleaning-in-place (C.I.P.) method.

If manual cleaning method is adopted, it must be clear that the pipes have to be dismantled frequently for cleaning operations and for this purpose, it is essential that approach to pipe lines is made very easy, i.e., piping system is easily accessible. For this piping supports from ground (floor) is preferred for supporting overhead pipe lines which are 7 to 8 ft above the ground level. Piping supports should be placed at a distance of about 3 meters or about 10 ft. All pipes carrying milk are of stainless steel as they are easy to clean. Sanitary piping is recommended for dairy industry.

For cleaning-in-place method, approach to pipe line is less important as piping will be dismantled relatively infrequently. Layout of piping in C.I.P. system has to be planned carefully because the purpose is not only conveying or carrying milk but also cleaning. Contamination has to be avoided in all cases. In large installations, it will be necessary to arrange for part of the pipe system to be cleaned while another part is conveying milk, and precautions and safeguards must be incorporated to prevent accidental contamination of milk by cleaning solutions or detergents. A milk piping must be so arranged to minimize loss of product at the end of process run to ensure that all cleaning solutions are removed from plant before use. For C.I.P. cleaning of pipe lines, milk piping may be supported from ceiling. In this metal suspension rods are fixed to ceiling. This gives a clear floor area with no obstruction and operations are carried out smoothly.

21.6 Can washing

Conditions and environments under which milk and milk products are processed are of great importance to customers. Pollution free environment and cleanliness become the prime factor for dairy industry. Cans in which milk is brought are often washed and cleaned well at dairy. Installation position and arrangement of can washing machine in relation to other respective equipment must be done in such a way so as to avoid contamination. The can washer must be installed in milk receiving room or at Milk Reception Dock covered from sides. It has to be placed adjacent to weigh tank (milk dump tank) in between dump tank and can washer, there will be drip saver so that any droplet left again goes back to weight tank. Milk may be transported upto tipping point on can trolleys or by means of conveyors. A stand by washing trough with cold and hot water facilities can be helpful in case of emergency. It will be clearly noticed that 'can cycle' ends at milk reception / milk receiving room only as after cans are washed, these are loaded on the same vehicle in most of cases and returned back to milk producers for next day bringing milk. Some space equal to one hour load capacity has to be kept on floor for washed empty cans as precautionary measure. Ultimately these have to be picked up within an hour's time. A minimum of 3 ft. distance is desirable between dump tank and can washer may be rotary or straightway can washer.

21.7 Pasteurizer, homogenizer and ice-cream freezer

As mentioned earlier under arrangement of processing equipment, pasteurizer and other relative equipment along with it have to be installed in order. But there are some other accessory equipment which are integrated into HTST and UHT pasteurizers. These are clarifiers, separators and homogenizers. Clarifiers and separators

when installed so as to operate on the heated product must be connected in such a way that they will not reduce the holding time below the legal minimum.

As all fluid milk and all ice-cream mix are homogenized, homogenizers are integrated into continuous pasteurizing systems. Homogenizing temperature must be at least 120 °F. The homogenizer must be located either between the regenerator and heater section or after the heater. Homogenizers work better when the product is delivered to the suction manifold under positive pressure than when they must draw the product into the suction manifold. The timing pump and downstream resistances supply the necessary pressure in most installations, but when there is a lack of pressure on the suction manifold, a centrifugal pump immediately upstream is recommended. It should be electrically connected, so that it can run only when homogenizer motor is running.

Ice-cream freezers and hardening room: Hardening cabinets (for small units) must be placed close to homogenizer. If a plant is incorporating a separate section for ice-cream making, then all relative equipment for ice-cream manufacture have to be installed in regular order sequence-wise.

21.8 Consideration of cleaning-in-place system

Cleaning in place C.I.P. means in place cleaning of equipment, i.e., cleaning solutions are brought to equipment and cleaned there only instead of equipment being dismantled and taken to separate place for cleaning. For proper performance of any C.I.P. system, all pipe lines must be properly fitted, properly pitched and rigidly supported. Special attention must be given to the supporting arrangement since proper support alone can assure maintenance of proper fit and pitch. Gaskets and joints which are protected from stress will be long lived and trouble-free. Conversely, joints subjected to strain because of vibration, lack of support or poor fit will invariably cut, deform and eventually fail completely. Ingenuity is essential in solving mounting problems at hand when installing C.I.P. system.

General recommendations regarding installation of C/A systems and C/A cleaned equipment are given below:

- (i) Tank trucks which are to be spray cleaned should be pitched at ¼ inch per foot from front to rear to provide for efficient high speed unloading and cleaning operations.
- (ii) Storage tanks that are to be spray cleaned should be pitched at ¼ inch per ft from rear to front to provide rapid drainage and continued positive recirculation of cleaning solution.
- (iii) Where tanks are associated fill-discharge header systems are to be mechanically cleaned, these tanks should be installed with the outlets 18 to 24 inches(45cm to 60 cm) above the floor, or higher, if necessary to accommodate the required number of lines. This height provides good return solution flow from tank washing operations and places all valves at a height convenient to the operator for product-flow control and cleaning.
- (iv) All product lines should pitch continuously to pumps being supplied by these lines.
- (v) All product transfer lines should pitch from a point above the transfer pump involved continuously if possible toward the constant level tank, storage tank, or filler bowl being supplied.
- (vi) All C.I.P. cleaned product lines should pitch continuously towards one or more drain ports.
- (vii) Tank cleaning return lines should pitch continuously from the tanker outlet valve to the cleaning return pump involved.

(viii) All connections should fit precisely, so that nipples and elbows can be easily installed and removed for making product piping and C.I.P. connections.

21.9 Arrangement of boiler house and refrigeration machinery

The boiler house is constructed on ground floor with approach from large bay for the removal and replacement of plant. The boiler accessories room is attached to it. Its ideal location is near most steam consuming areas especially milk drying and condensing. It should be on one side of the building away from prevailing winds, if solid fuel is used for obvious reasons of dust and ash. Fuel storage must be adjacent to the boiler house and must have good approach for transport. In any case boiler section must be away from main processing sections.

Refrigeration machinery should be planned so as to locate it centrally. The compressor room and chilled water tank may be placed in a basement and this may have some advantage in warm climates. A ready emergency exit must be provided in the room. It is preferable to have refrigeration room on the ground floor as it will be easy for installation and replacement of equipment. In large plant compressor room may be near the boiler in a separate building

21.10 Conveyors

Whenever question of material handling comes, thought must be given to available material handling devices, such as, cart, trolleys, fork lift truck, conveyors, etc. All these devices save labor and time. Not only efficiency is achieved but delays are also curtailed. Out of all these for constant and organized movement of the product from one point to another conveyers are the best. Other devices are good for small operations. Conveyors should be properly laid out, timed and provided with convenient shut off switches. They should be so located that they do not block passages. Automatic controls for speed control and stopping in the event of a pile-up are desirable. The length of conveyor between two pieces of equipment is important and serves as a storage to aid in synchronizing the speed of the two machines. This storage function gives the operator a brief period in which to correct minor difficulties with a machine without stopping the entire line. Conveyor sections can be mounted on wheels which can be rolled into position to extend the fixed conveyors to load trucks, if necessary.

Types of conveyors

Conveyors move cases and cans faster and more efficiently than men and this increases the proportion of time workers who can spend more time on actual production work. The most common types of conveyors used in dairy industry are:

1. Chain conveyor
2. Belt conveyor
3. Gravity conveyor (roller conveyor)
4. Wheel conveyor

Chain conveyors are the type most widely used in the dairy plant to convey crates, cans and other packages. Chain conveyors are of three types: (1) above floor type, (2) in floor type, and (3) on floor type. Regardless of the type, every chain conveyor system consists of 4 basic parts, namely (1) power unit, (2) conveyor frame, (iii) chain, and (iv) take up unit.

All complete chain conveyor systems may consist of one or more power units depending upon the size of the plant and the complexity of the package handling flow in plant.

Above floor chain conveyors have an open type steel welded or bolted frame. The chain is pulled along in the hardened steel chain tracks mounted in this frame – usually foot above the floor. The return chains run in channels mounted in the frame below the carrying chains. The standard chain height for an above-floor conveyor in most plants is between 18 and 22 inches. This is because the top of the case is generally 30 to 36

inches off the floor, which is the most convenient working height for most washer and filler operators. This type of conveyor is used to convey single cases and cans. The conveyor frame has side rails that extend up above the top of the chain to keep the case and can on the conveyor.

The in-floor type conveyor is a double chain conveyor imbedded in the floor. The in floor type conveyors cost same as above floor type conveyors except that installation cost is slightly higher because of the necessity of supplying in floor pits for drives and take up units. Also cost of additional work required to imbed the conveyor in the floor flush with floor level. The frame consists of a steel plate 1/8 to 3/16 inch thick, formed with channels for the carrying and return chains, so that the overall width of frame is about 16 inches. The conveyor frame is embedded in the floor. The two carrying chains are usually ½ inch above the floor level. The return chain travel is between and below the carrying chains.

In-floor conveyors must be planned in the initial stages, because a floor channel has to be provided to accommodate them and to house driving motor. The pits for driving motors are made large enough for cleaning and maintenance and are covered by removable steel plates or grids. With in floor conveyors, the entire area where the conveyor is located is free from those conveyors which must be climbed over to get around the plant.

Belt conveyors

Belt conveyors are used in dairy plants for carrying cases between floors in multistory plants. These are also used in the dry storage warehouses for unloading warehouse items from delivery trucks. Belt conveyors are not suited for handling milk cans.

Gravity-roller conveyors and wheel conveyors

Gravity-roller conveyors and wheel conveyors are used today to a limited extent. These conveyors find their use in warehouse and for short sections or lift sections at the end of power conveyor systems. Wheel conveyors are ideal for warehouse operations because they are light in weight, portable and are easily moved around in the ware house.

Bottle conveyors

Bottle conveyors are of two types, namely (1) Flat link, and (2) the lateral curve. Both have a smooth level surface and can be used for either glass or paper bottles. It will be noted that bottles require slat conveyors to give the necessary area of flat surface for stability. Bottle conveyor is a type of chain conveyor using chains which may have from a 1 to a 4 inch pitch. The drive unit is usually of the gear-motor variety located at one end of the conveyor and pulling the chain through the system to an idler sprocket at the other end. The chain runs on a frame between the rails. Conveyors are installed as per requirement of a particular section.

21.11 Typical equipment layouts:

Typical equipment layouts are shown in the Fig. 21.1, 21.2, and 21.3. For preparing equipment layout typical symbols are used for different equipments to prepare its layout, Fig. 21.4 shows symbols for different equipments.

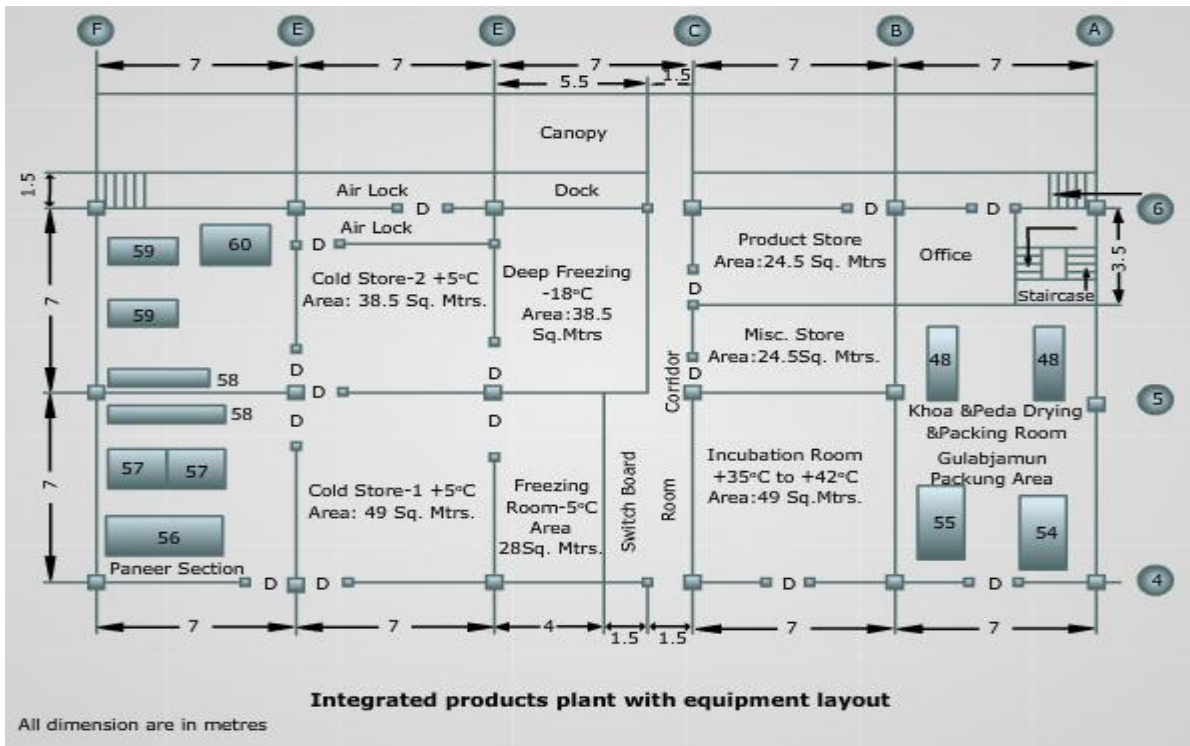

Fig. 21.1 Integrated product plant with equipment layout

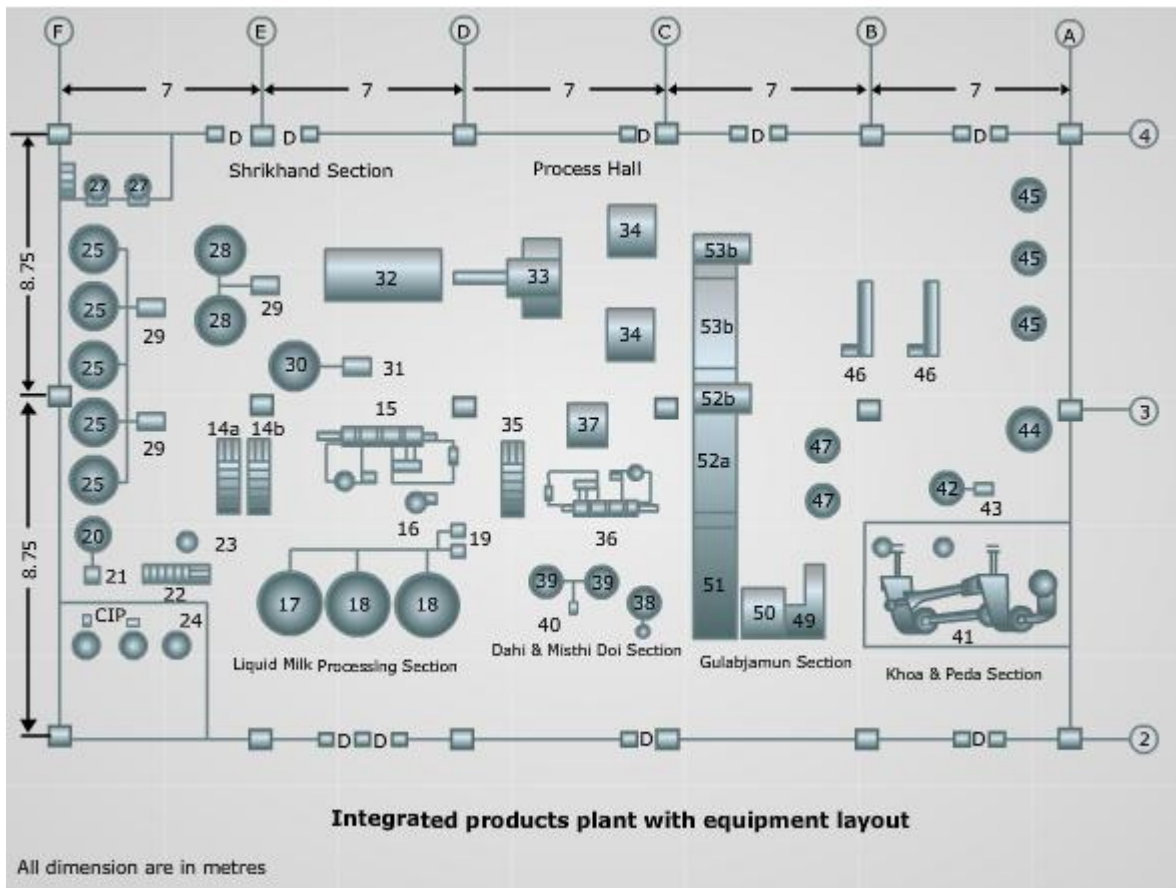

Fig. 21.2 Integrated product plant with equipment layout

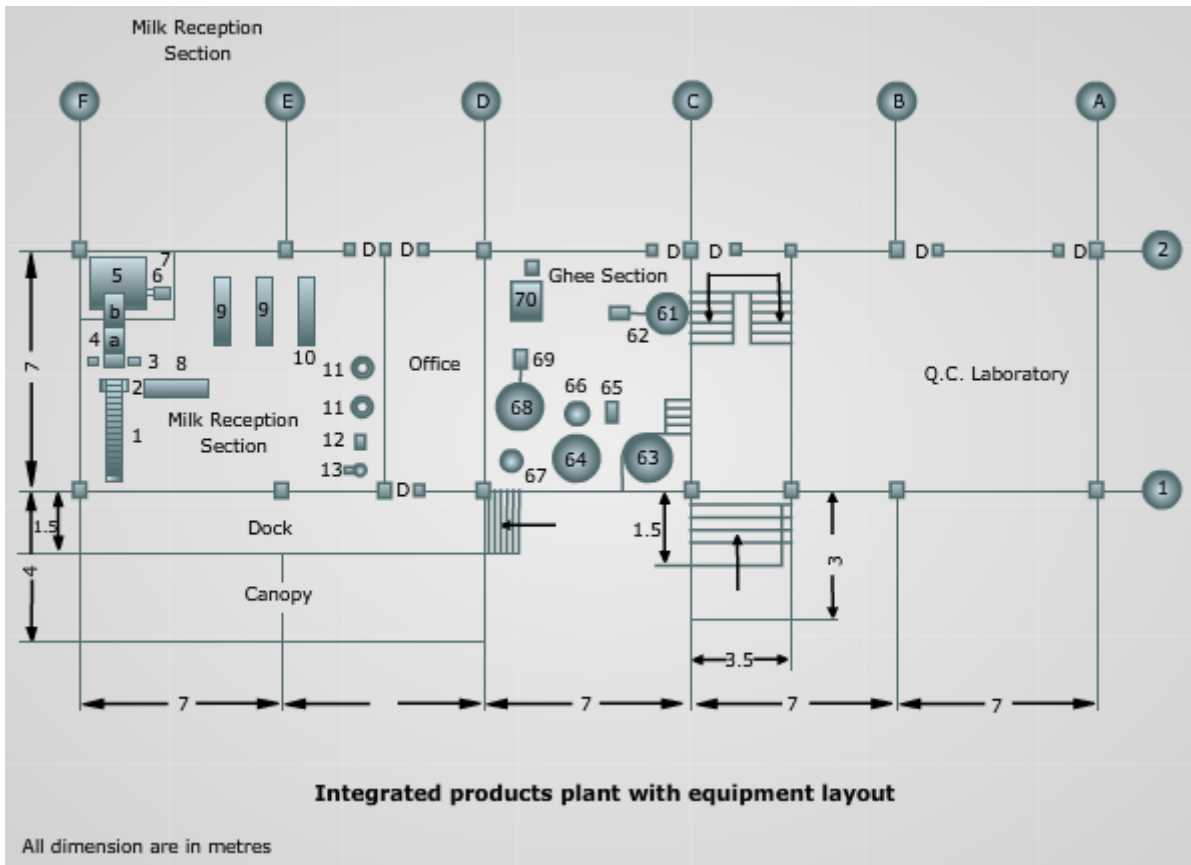
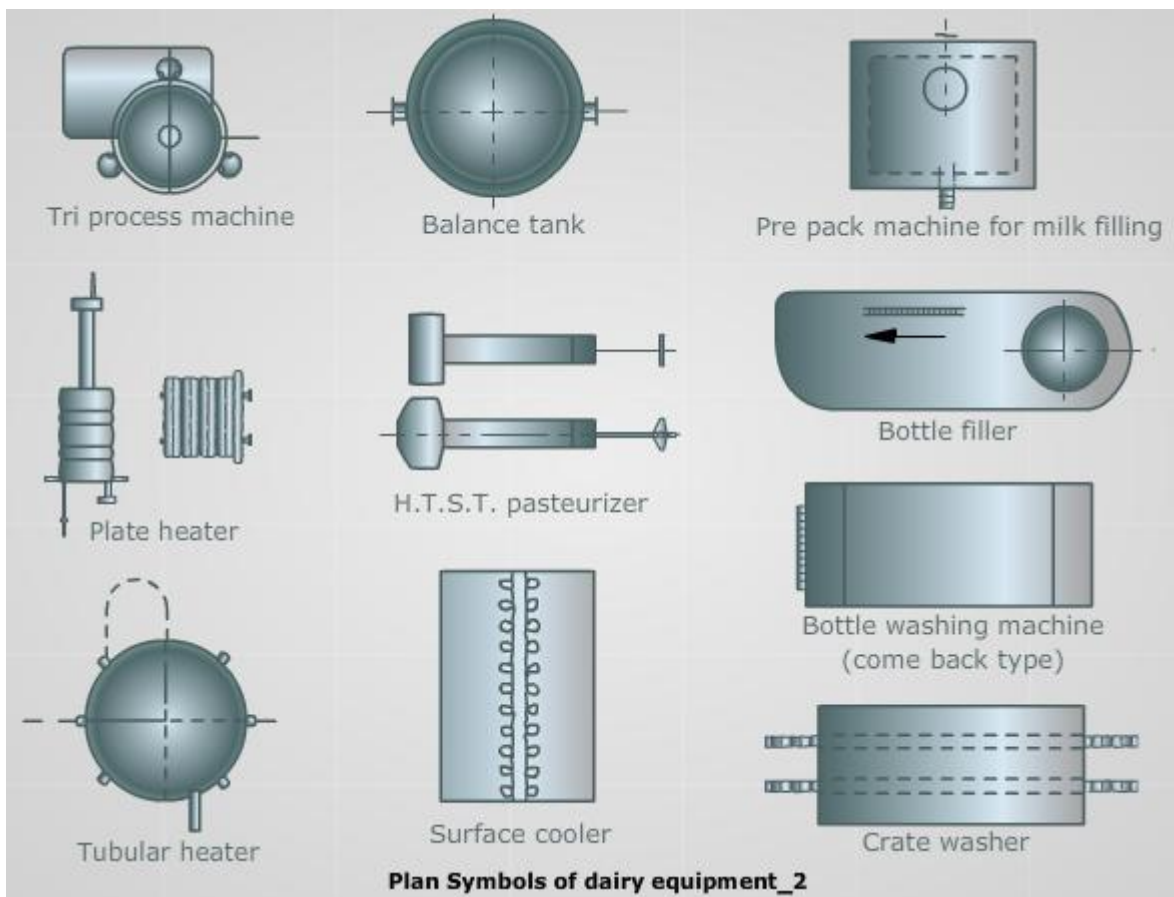
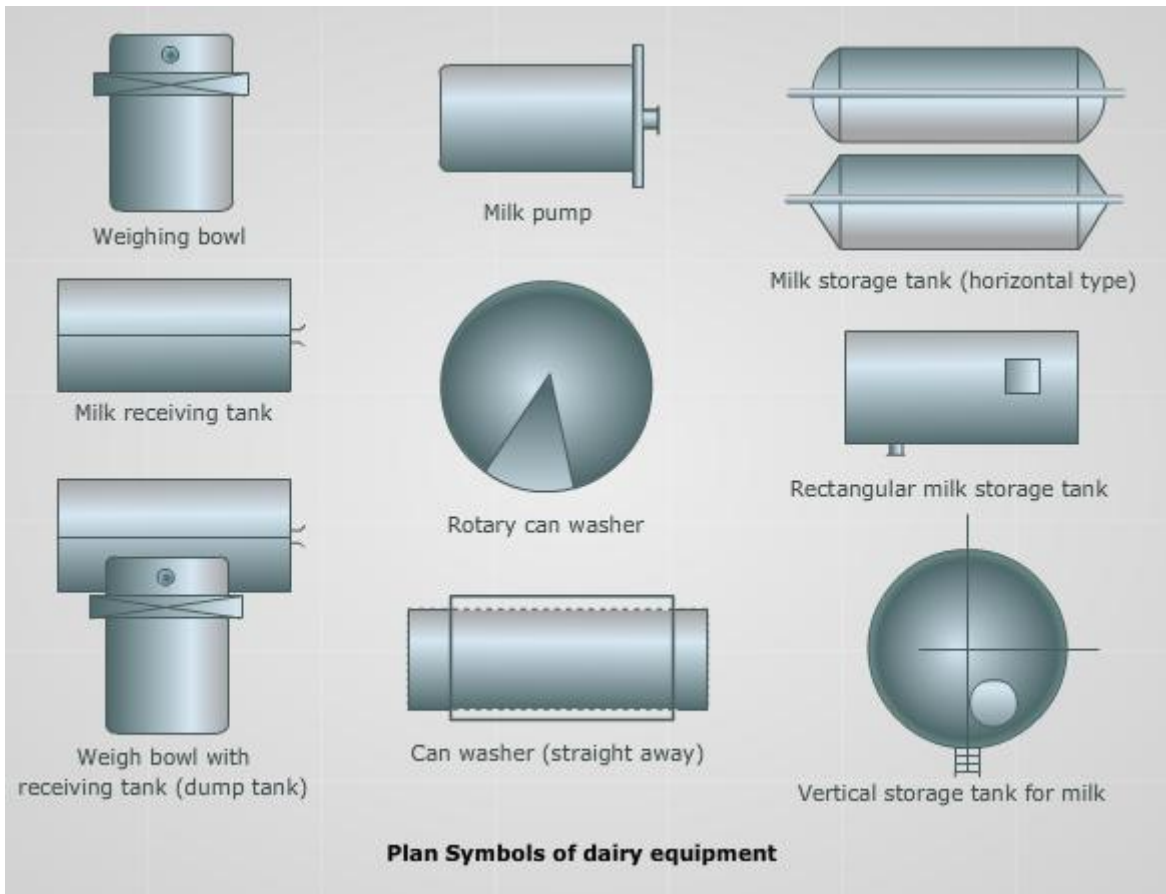
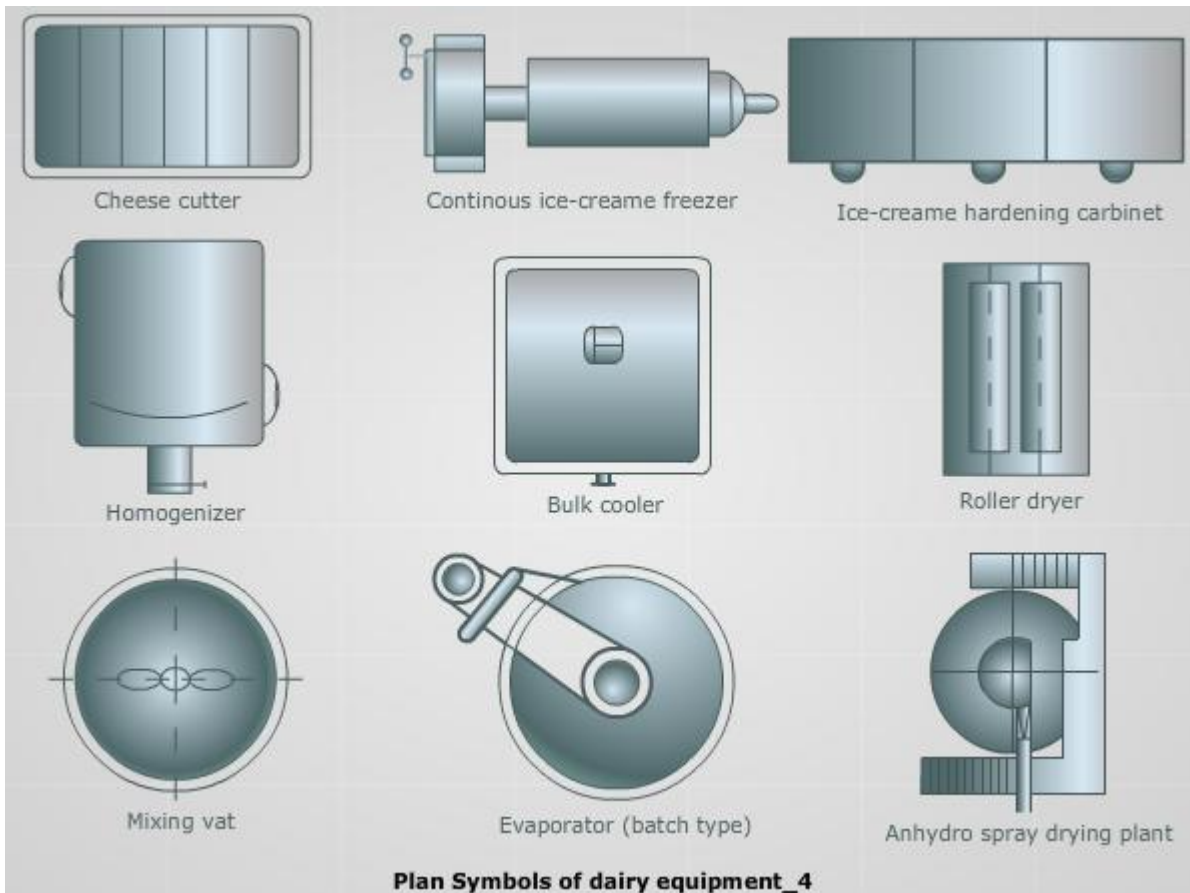
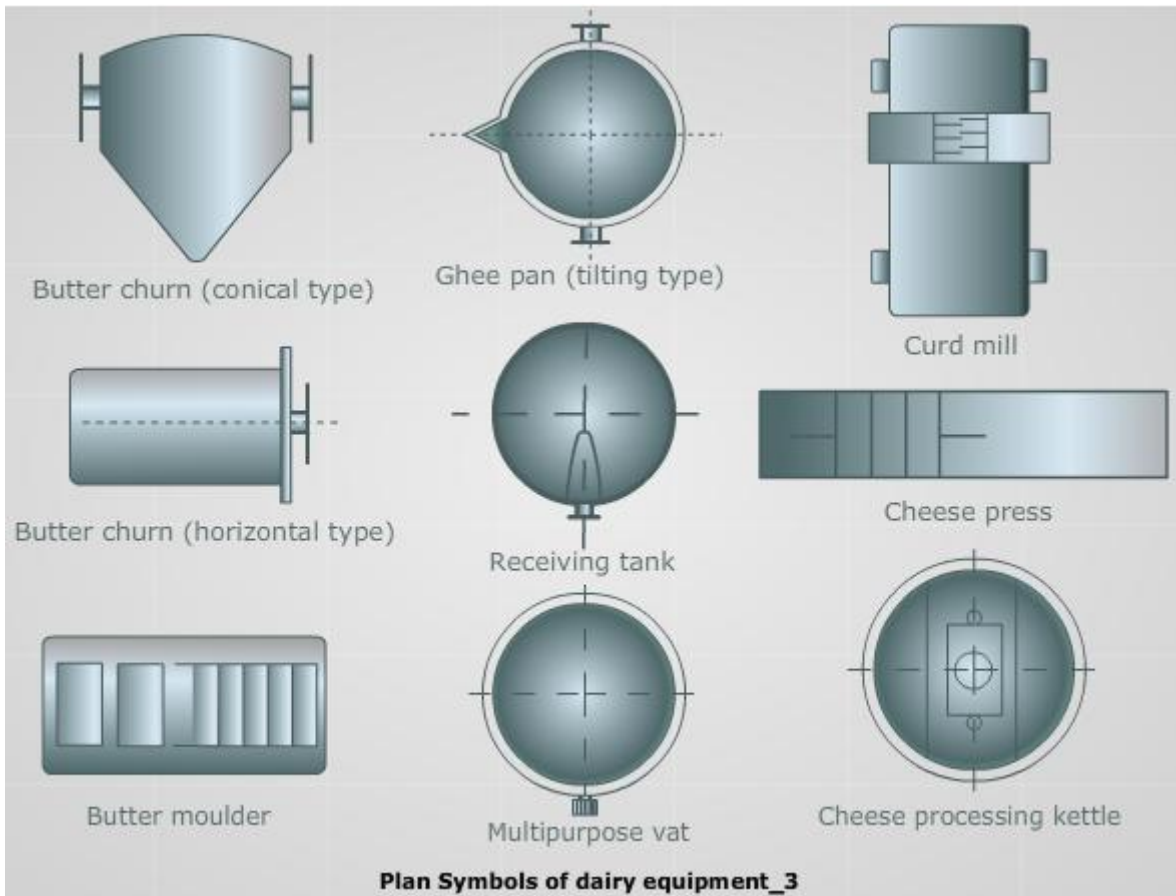
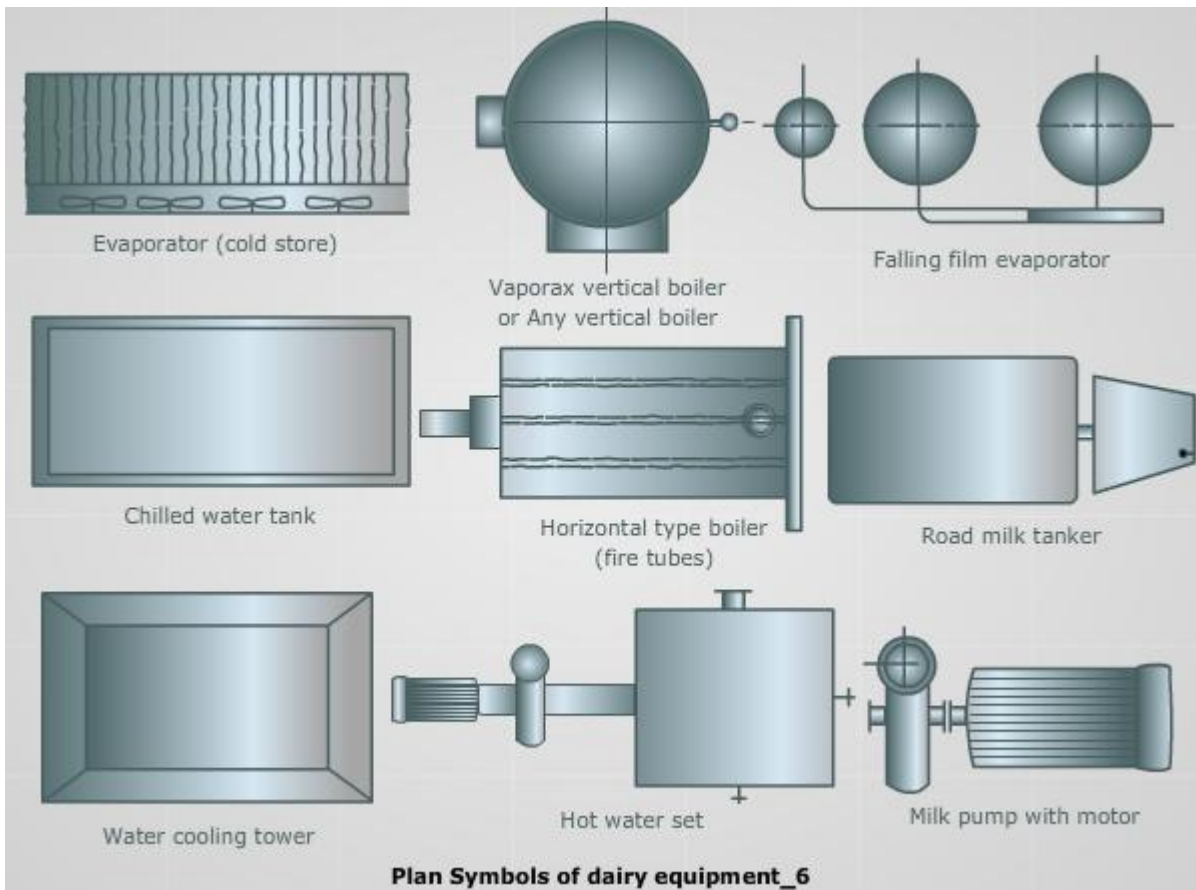
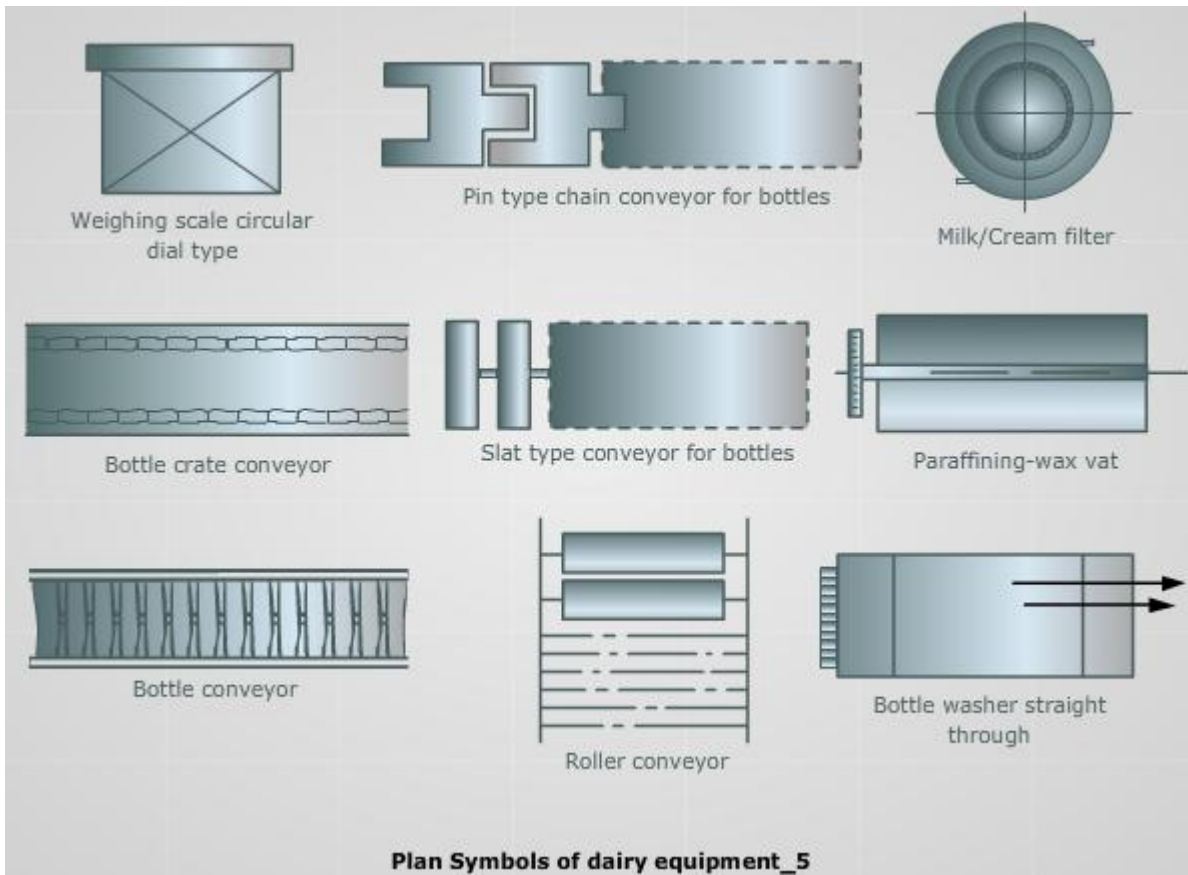

Fig. 21.3 Integrated product plant with equipment layout

The Following figures (21.4) shows symbols for dairy equipments.







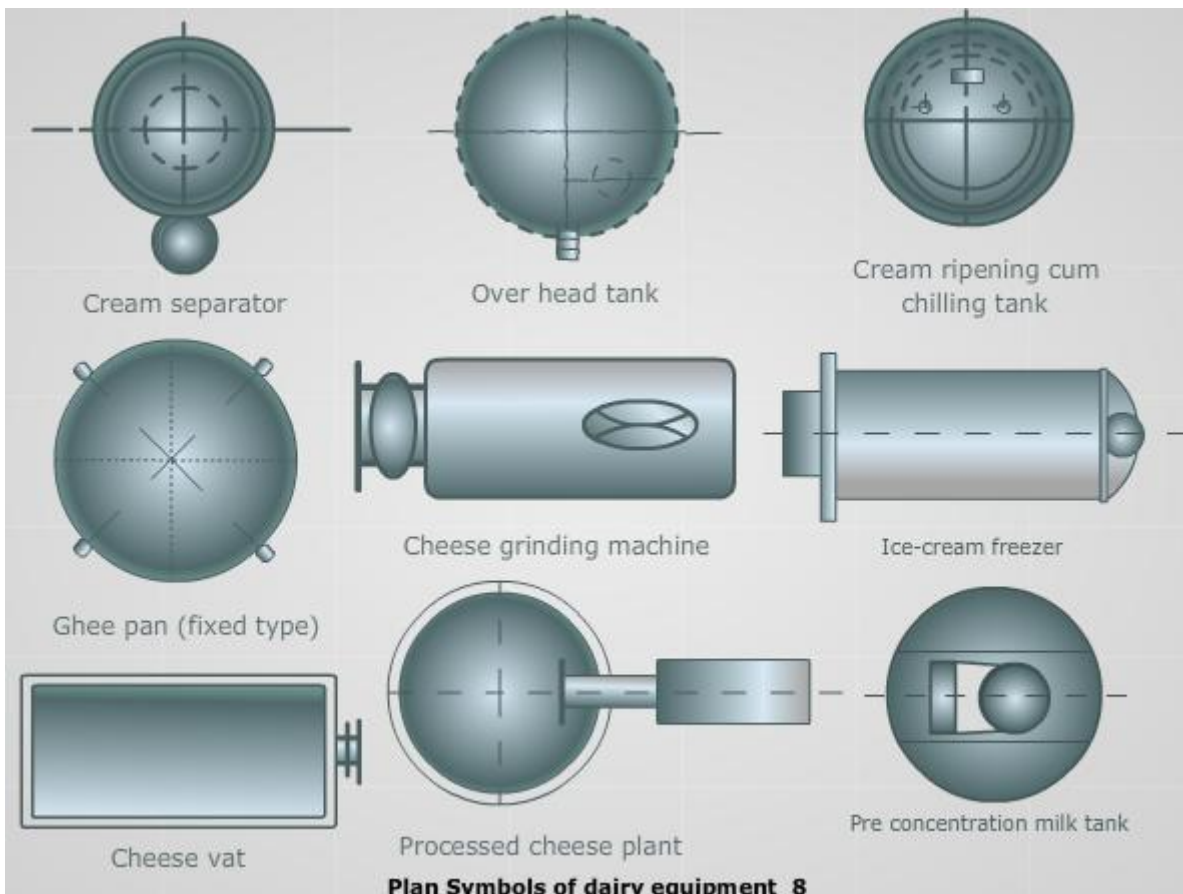
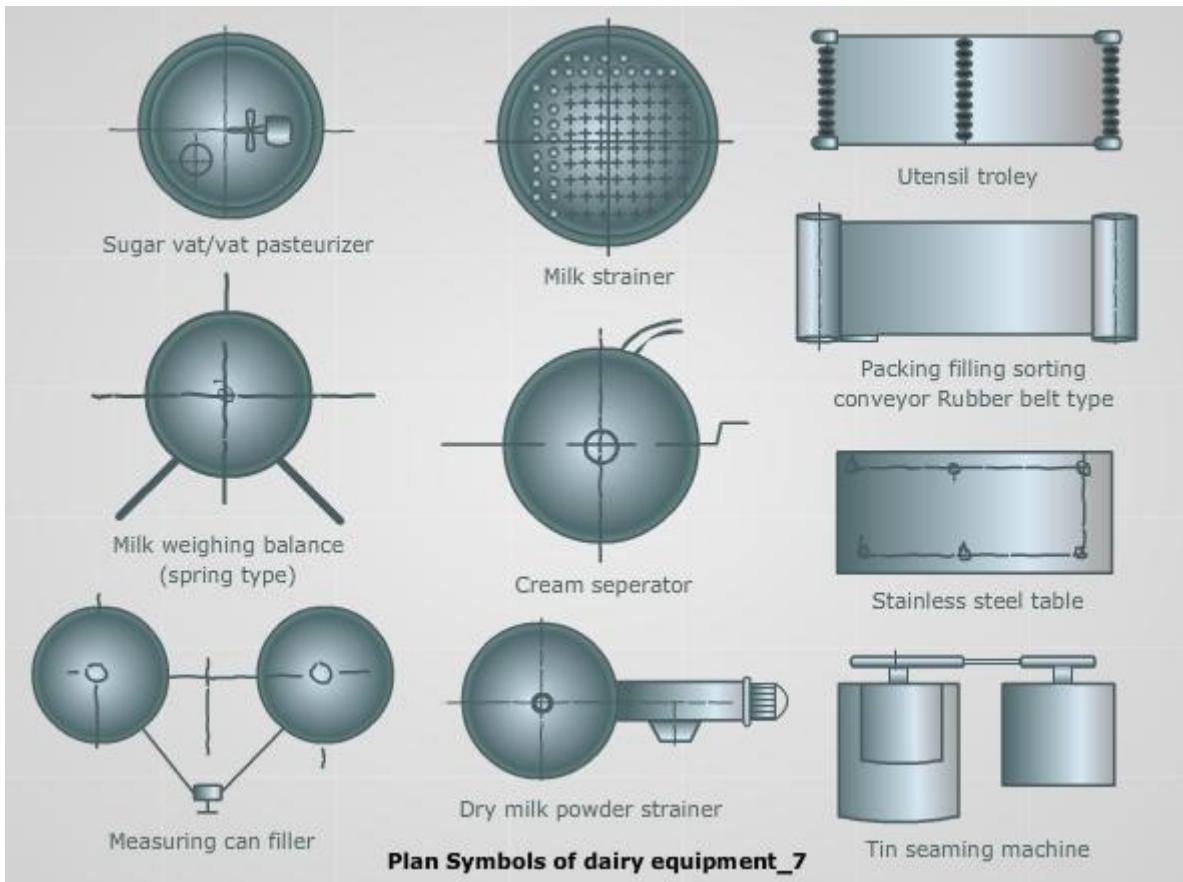

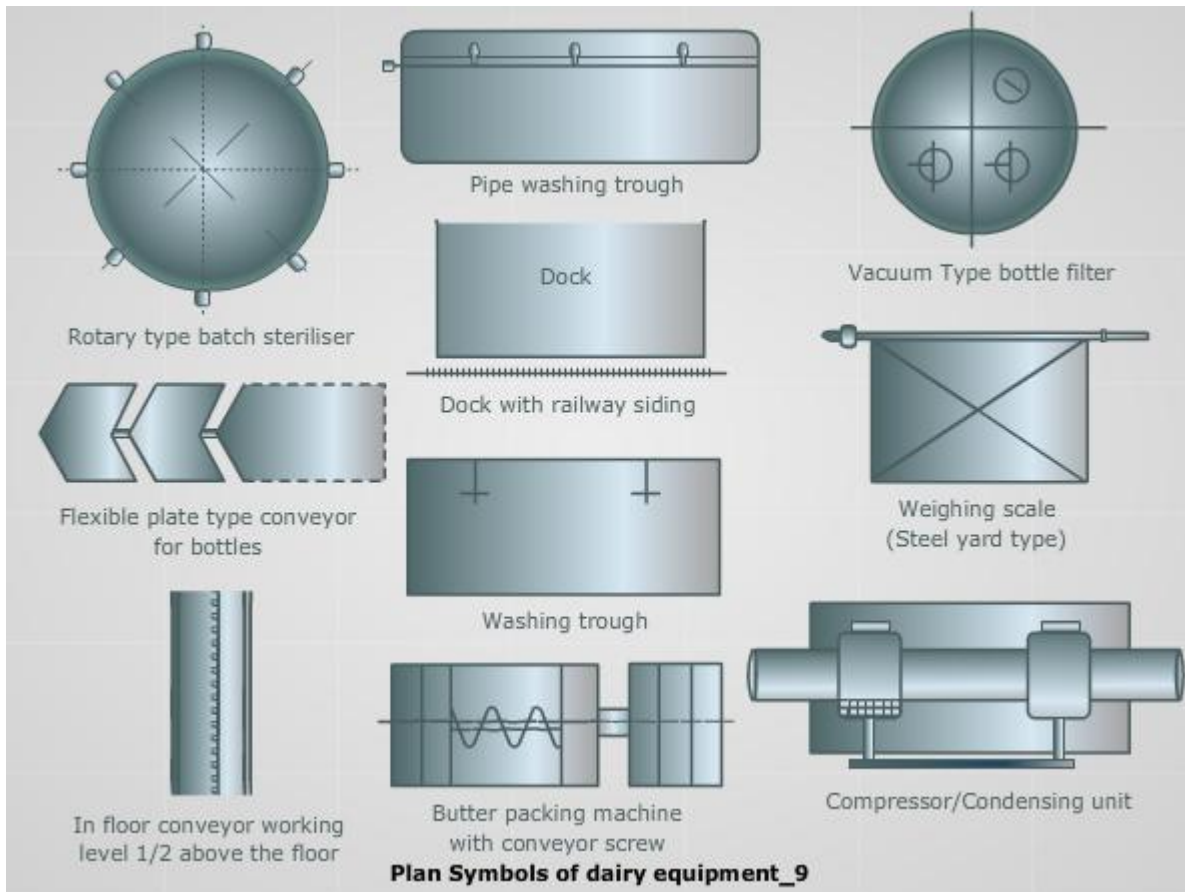

***** 😊 *****

Lesson 22

Layout of offices and workshops

22.1 INTRODUCTION

Layout of offices for general manager, managers, supervisors and technical officers are planned in a such a way, so that all the processing operations can be monitored from the glass window of the offices. Further the locations and layout of the process control room should be in the center of the processing sections, so that instructions can be given to the operator after visual monitoring of the activities. The location of the workshops for the repair and maintenance should be near to the major sections where it is required e.g. near boiler section, near refrigeration section etc. The layout of offices and workshops should permit easy operations and monitoring.

22.2 Office layouts and their linking with dairy plants

A dairy factory will not have only technical, dairy professionals, operators, skilled and unskilled workers, but will also have staff personnel not directly concerned with plant, but very much associated with dairy. This staff looks after all activities of dairy such as administration, milk procurement, processing, dispatch, distribution, sales and marketing of products, establishment, finance and accounts, H.R.D., security (watch and ward) and management in general.

This staff requires office accommodation comprising number of rooms properly linked. For employee comforts and convenience, staff canteen, toilets, reception lounge have also to be provided. Size of office varies with the capacity of the plant. A small dairy may have small office as number of activities will be less. Medium size dairy plant will have bigger office as compared with small dairy. In this number of activities will be more and plant may be manufacturing more products. Accordingly, staff will increase. A large dairy will still have large office with large number of staff employed. Before deciding number of rooms in office and space requirement, it is essential to know the activities, number of departments and persons who can handle the work, as number of persons employed will determine the area and room needed by them.

A small dairy may have sections or departments viz milk procurement, milk processing, milk dispatch and distribution, sales and marketing, advertising, sanitary control and hygiene, security (watch and ward), establishment, finance and accounts, dairy technology and dairy engineering.

Medium dairy will have all above departments, but there may be addition of two or more sections, such as labor welfare department (office), human resource development (H.R.D. section), personnel department etc. Large number of employee and labor justifies the existence and importance of additional sections mentioned above.

In small dairy office, there will be one Manager who will be assisted by various Sectional Heads with suitable designations. Each Sectional In charge will have 2 or 3 Assistants/Clerks and one Peon or Attendant. All staff will be housed in a separate building or block which will be suitably linked with dairy, except for security office which will be located near the entrance or gate of the factory. Officer Incharge of a particular section will have his room next to his working section for easy approach and supervisory reasons. For instance, Accounts Officers' room will be immediately next to Accounts Department or Section.

Medium-sized dairy plant may have one General Manager, one Deputy General Manager, one Manager, three Deputy Managers, six Assistant Managers, twelve Sectional Heads with suitable designations and three Assistants or Clerks with two Peons or Attendants in each section.

Accommodation for all these staff members has to be provided and carefully planned keeping logic in mind. Sufficient space has to be provided for walk ways, passages, corridors and reception lounge with visitor's waiting room.

Large dairy plant will have big office layout with large number of employees at different levels to manage various departments. Staff pattern in large dairy organizations is somewhat different from other two small and medium size dairy plants. Here above General Manager, there is Managing Director; Board of Directors presided over by Chairman of the company. While deciding accommodation and room layout for office of this magnitude, it is essential to make provision for Chairman's office, Board Room (Conference Room), Guest Room / Guest House etc. It is a good practice to work out detail staff required at all levels in the factory including office and plant works. The organization chart may be drawn, which will give clear picture of staff position. Accordingly, office layout can be prepared. Refer Part B of the book chapter titled 'Office Layouts'.

***** 😊 *****

Lesson 23

Material handling

23.1 Introduction:

The modern dairy plant today is faced with continually rising labor cost, higher prices of milk, equipment and suppliers. As a result the progressive plant operator and equipment manufacturers have given considerable thought to the development and application of automatic equipment and controls to reduce man hours per unit of product, decrease product and container losses, and to increase overall plant efficiency. As operating costs increase more product per man-hours at a lower cost per unit must be realized to maintain a profitable operating balance. Progressive dairymen today are recognizing the need for the development and use of modern material handling methods and equipment for the materials handling phase of any dairy plant operation.

In setting up operations and designing material handling systems, it is essential that an analysis be made of the entire plant product flow. This analysis show the raw product in, the major product movement, the specialized or branch movements, the processes, the storages for the various products, and the out movements. It is particularly important to note the areas where high density traffic is found. It is also important to note the sequence of movements and provide for them so that the whole operation will move forward smoothly. The designer should take advantage of the many new material handling methods and equipment, utilizing each one where it is crates, cans, etc. can be moved by means of chain conveyors or they may be moved by trucks or pallets. Surprisingly enough, there may be places where some handling can best be made by means of manual labor.

Material handling systems for food products should be carefully selected so that it will not be affected by temperature change or severe vibrations. The material handling system should be simple in design, having ease of lubrication, corrosion resistant and low maintenance. The use of automatic stopping and starting controls, speed regulators, switches, and over-load safety devices are all important. Fig. 23.1 shows concept of material handling system in the dairy plant.

23.2 Material handling systems for dairy plant

The key raw material for any dairy plant is milk. The raw milk can be procured in different vessels, generally cans of 5, 10, 20 and 40 liters capacity of aluminum, stainless steel, food grade plastic can be used (Fig. 23.2 (a), (b) and (c)). The milk can be procured in cans by truck (Fig. 23.7) or in road tankers (23.8). The milk can be transported for long distance by rail tankers. To reduce microbial load and to increase shelf-life of the milk cold chain is maintained during handling and procurement (Fig. 23.4).

The milk cans received at dairy plant can be handled by gravity or chain conveyors (Fig. 23.3 (a), (b)). The milk received by road tankers can be directly pumped to the silo (Fig. 23.6). The viscous and powdered products can be conveyed by screw type of conveyors (Fig. 23.3 (c)).

The boxes and blocks (cheese blocks) can be transferred from one place to another place by pallets and it can be racked and stacked in the rooms. The powdered products can be conveyed by blowing the air or by suction using air ducts. The material handling systems for different products can be designed using automation, so that material can be handled with minimum labor and damage to the product.

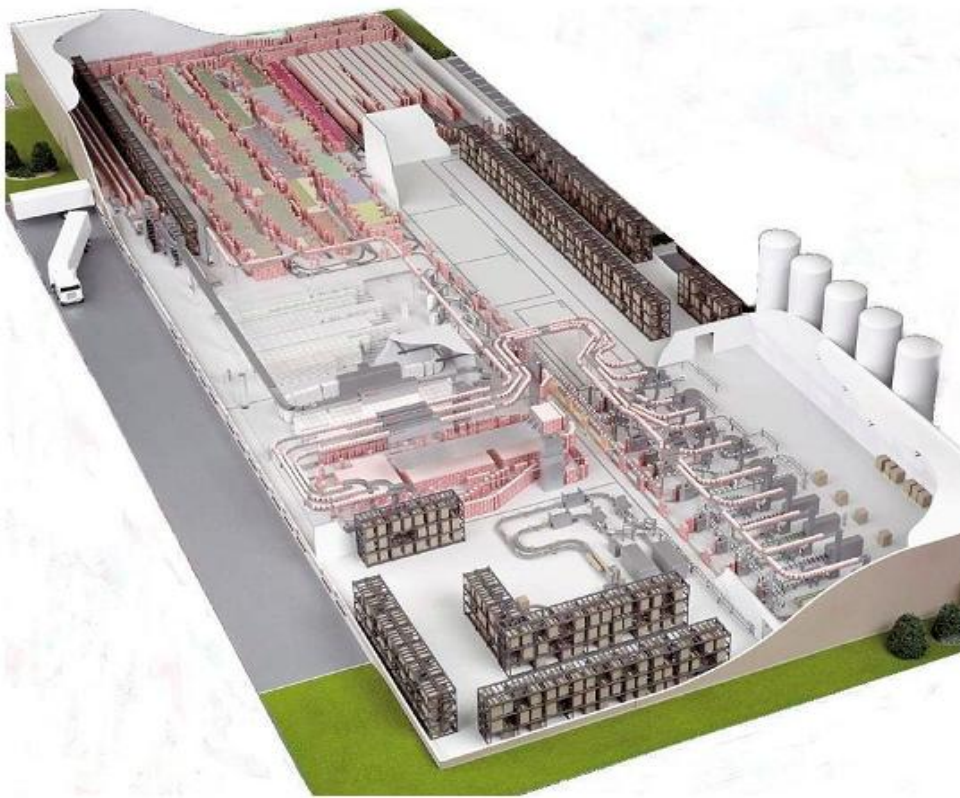

Fig. 23.1 Concept of material handling in the dairy plant



(a) Al-Milk Cans



(b) S S Milk Cans



(c) Plastic Milk Cans

Fig. 23.2 Milk Cans



(a) Chain Conveyor



(b) Belt Conveyor



(c) Screw Conveyor

Fig. 23.3 Conveyors for dairy plant



Fig. 23.4 Bulk milk coolers

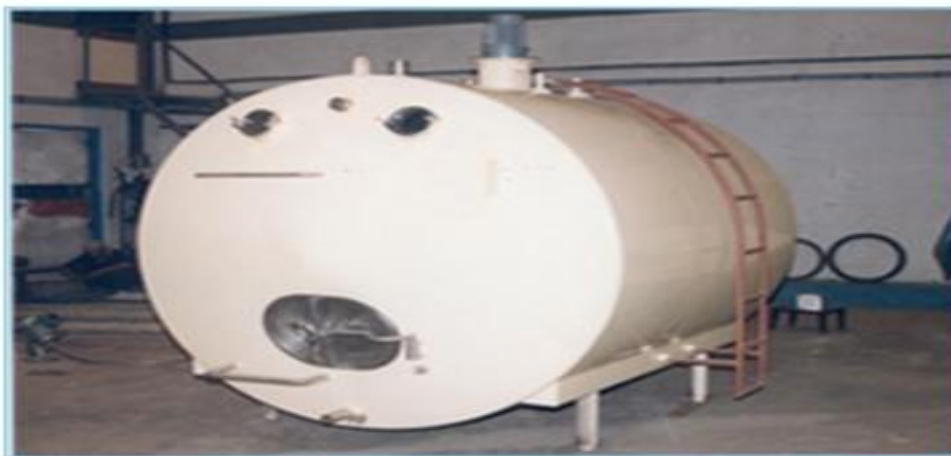

Fig. 23.5 Storage tanks for milk



Fig. 23.6 Milk Silo



Fig. 23.7 Trucks handling milk cans



Fig. 23.8 Road milk tanker



Fig. 23.9 Pallet for racking and stacking

***** 😊 *****

Converted into PDF By:



AGRIMOON.COM

All About Agriculture...

Lesson 24

Preparation of detail layout with model planning

24.1 Introduction:

Preparation of detailed layouts and model planning for the dairy plant is very much important to provide specific information which is required by entrepreneur and technical persons implementing the project. Different types of dairies manufacturing different dairy products will need different kind of equipment, service pipe line, and sectional layouts. The material of construction will also differ depending on type of product to be manufactured. Therefore it is very much required to prepare detailed layout with all details along with model for the dairy plant.

24.2 Preparation of detail layout and dairy plant model

Preparation of detailed layout for dairy plant with equipment layout, service pipeline layout and sectional layout is a joint venture of dairy manager, engineers, architects and administrators, and it forms overall managerial functions. A knowledge of managerial policy with respect to future volume of production and size of a business firm is of particular importance to the dairy layout engineers, because it points to the need for providing for future expansion or concentration in the plant layout for efficient planning. A good layout must (i) improve or facilitate production operation, (ii) minimize material handling, (iii) maintain flexibility of the operation for alteration and expansions and (iv) promote effective utilization of the labor force and provide for employee convenience and comfort.

The dairy plant model is prepared before going for actual implementation of the project and suggestions are invited from the group of dairy technologist, engineer, architect, administrators and policy makers. The plant building should form an attractive look by proper designing and construction. Good design and construction can be made even more attractive by neat surroundings that results from proper care and landscaping. Single story type construction is commonly preferred because loads on the floors are transferred to the ground rather than supported by structural parts of the buildings, trucks and conveyors replace stairs and expensive elevators, capital investment is less if land is available to spread construction, and building maintenance and plant expansion are simplified.

Mainly there are four basic types of layouts, namely straight line type, 'L' type, 'U' type and 'T' type. In most cases straight line type is favoured in respect of small creamery factory because not much interference is there from utility sections and also it provides easy supervision facilities. If possible, single storey building with straight line or 'L' type layout should be preferred. The shape of the plot will immediately give an idea as to which type of layout is best suited. A single line skeleton layout for a small factory is appended for general idea in Fig. 24.1

Space required by an equipment depends upon capacity and dimensions of equipments to be installed. If area of each room is known, then by totaling area of all rooms, area of entire plot can be found. For approximate calculations, an area for processing room should be at least 5 times equipment area. Space in between the equipment and around equipment should be 3 feet. The overall area of plant may be taken as 3 sq. ft/ 5 litres of milk handled per day. This will include office areas for large plant buildings. There must be enough space around factory building for roads and parking.

Planning for dairy plant building, various sections and equipment installation would require careful thinking and suggest that processing room, storage and office room should be initially made sufficient large enough so that, if expansion is there, the main set up is not disturbed. Equipment installation will follow processing concept, i.e. sequence order of operation for forward flow of product, keeping in view short routes and minimal travel of persons and materials.

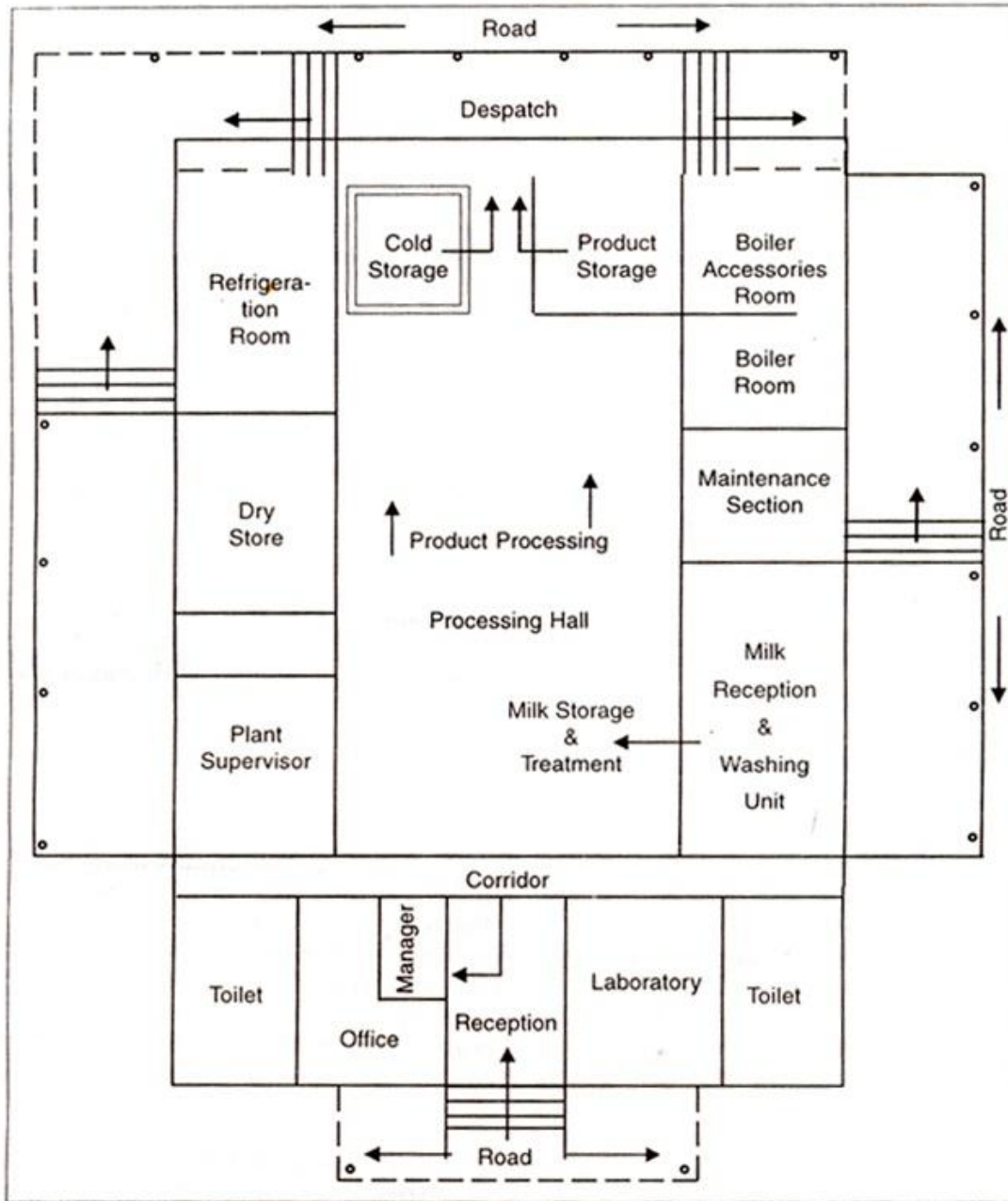

Fig. 24.1 Concept for layout of dairy plant

***** 😊 *****

Lesson 25

Common Problems

25.1 Introduction:

The design of a dairy building is most important and must be done very carefully. The design depends upon the handling capacity, that is the quantity of milk to be processed and the quantity of milk products to be prepared. There are some of the typical problems related to plant designs are:

- (i) Lack of harmony between plant location and economic environmental conditions
- (ii) Process equipment selection, influenced by local personal interest
- (iii) Modern processing lines with auxiliary equipment requires planning, designing and layouting at initial stage.
- (iv) Lack of heat and water recycling system, material handling and poor management.
- (v) Modern process and new building quickly deteriorates due to improper operation and lack of maintenance.

25.2 Remedies to the problems:

In order to avoid above problems a systematic approach to planning, designing and layouting of dairy plant should be employed. To change equipment and process is almost always possible, but change in concept of building layout, infrastructure and environmental conditions of the dairy plant is hardly possible. Therefore an optimum plant design concept based on Integrated Project Engineering Method (IPEM) should be used.

Integrated design of dairy plant building and services for a new factory has made possible higher processing efficiency and better product quality with minimum energy consumption, capital investment and operating cost. Traditional designs were changed and engineering services and equipments are provided with turn-down capacity in order to meet these optimized objectives and to have reduction in energy consumption, reduction in capital expenditure, reduction in equipment cost. The total layout coordinates all functions and labor utilization and may be brought of as two inter related parts i.e. equipment layout and sectional layouts, to have smooth functioning with efficient heat utilization and minimizing the energy in conveying the products.

25.3 Concept of Integrated Project Engineering Methods (IPEM):

A systematic approach to the planning of dairy plant is needed to guarantee their economic operations, which exists in future are successfully predicted. An Integrated Project Engineering Methods (IPEM) has been developed for this purpose, which is based on

- (i) Optimization of processing in sequence
- (ii) Maintaining the food safety and hygienic requirement
- (iii) Optimization of plant design using complex optimization or technical process together with auxiliary plant, and
- (iv) Introducing automation, process control, and on-line measurements

MODULE 5. BUILDING CONSTRUCTION MATERIALS AND TYPE OF BUILDING CONSTRUCTION

Lesson 26

Choice of building construction materials - Brick, sand, cement, lime etc.

26.1 Introduction

The building materials used vary considerably in different parts of the world. Though, basic materials used for the construction of dairy plant are common in almost all countries. More emphasis has been given for the materials which are commonly used in India. The use of cement, bricks, cement concrete, RCC, steel, stone etc. are very common in most countries. In recent years, pre-fabricated blocks and pre-stressed RCC blocks are being employed for various applications. It is necessary to consider several factors such as environmental conditions in the plant, whether conditions, wear and tear, effect of acid and alkalis, safety, cost etc. for the selection of materials for different sections of dairy plants.

26.2 Factors to be considered for selection of building construction materials

- Effect of atmospheric conditions on the building
- Effect of prevailing conditions in the plant such as water, water vapor, high temperature, acids, alkalis and wear and tear.
- Durability of material under conditions to which it is exposed
- Ease of cleaning and maintenance
- Availability of the materials
- Cost of materials

26.3 Properties of building materials

The properties of different building materials are discussed in 26.4. Some general properties which are to be considered are discussed here. The use of building materials of organic origin which may be attacked by bacteria and other organisms should be avoided. Whenever soft wood and wood based products are necessary, protection against germs and moisture is very essential requirement. Many hardwoods such as teak have shown good serviceability for use of window frames, doors etc.

Insulating materials must be well protected to prevent entry of water vapour. The use of PUF panels for insulation of cold storage has changed the entire construction requirement of cold storages. The use of paints and bonding materials of organic origin should be avoided. The building materials are exposed to corrosion environment in dairy plant must be protected. Iron under moist condition rusts quickly and hence it must be protected by galvanizing, zinc coating or painting. The condensation of water vapor on a wall or pipelines may cause corrosion of metals and seriously damage the paint. Therefore, removal of water vapour from the processing room be taken into account.

26.4 Building Materials

Generally building materials are classified into three groups as under.

- (i) Solid materials – stones, bricks, iron etc.
- (ii) Cement Materials – lime, cement etc.
- (iii) Protective materials – paints, varnishes etc.

26.4.1 Bricks

Clay is the basic raw material for the preparation of bricks. Clay for brick is composed of alumina and silica and certain fluxing ingredients such as ferric oxide, lime, magnesia or CO_2 in quantities up to 20% except in firebrick, which may have silica content as high as 98%.

Bricks are obtained by molding clay in rectangular blocks and then drying and burning of those blocks. It is manufactured by many places throughout the country in unorganized sectors. Brick is widely used as building material for making walls and as compared to other materials used for this purpose, it is cheaper. Brick contains alumina, silica, lime; oxide of iron, magnesia etc. and each constituent imparts specific characteristics in brick.

26.4.1.1 Properties of Brick

- Good quality brick should be well-burnt in kilns, uniform in size and color, clear metallic ringing sound when struck with each other.
- No brick should have crushing strength below 5.50 N/mm^2 . The bricks should not break into pieces when dropped flat on hard ground from a height of 1 m.
- Absorption of water should be more than 20% of its weight in 16 h immersion in water.
- Crushing strength: As per BIS, minimum crushing strength of brick is 3.50 N/mm^2
 $7 \text{ to } 14 \text{ N/mm}^2$: A grade
 $> 14 \text{ N/mm}^2$: AA grade
- Hardness: Bricks should be sufficiently hard.
- Presence of soluble salt: bricks should possess minimum salts.
- Shape and size: Rectangular shape with sharp edges. (Size: $190 \text{ mm} \times 90 \text{ mm} \times 90 \text{ mm}$ (recommended by BIS))
- Soundness: Clear ringing sound when two bricks are struck with each other.
- Structure: homogeneous, compact, free from any defects like holes, lumps.

26.4.1.2 Constituents of good brick

(i) Oxides of aluminum (Al_2O_3): This ingredient renders the plastic property in the material required for molding. However, excess of it causes the raw brick to shrink & warp, while drying.

(ii) Silica or sand (SiO_2): It prevents the raw bricks from warping, shrinking and cracking. But excess amount of silica may cause brittleness.

(iii) Lime (CaO): Lime helps in preventing the shrinking of the raw bricks. A small proportion of lime present in a finely divided state also acts as a flux and causes the sand to fuse and bind the particles to gather. Excess of lime causes the brick to melt and run out of shape. Lumps of lime become quick lime after burning and when the brick is immersed in water or absorbs moisture from the air, the quick lime slakes, expands and causes the brick to split into pieces.

(iv) Oxides of iron (Fe_2O_3): A very small percentage of oxide of iron is helpful in (a) causing the sand to fuse a little at low temperature giving a pleasing tint to burnt brick.

(v) Magnesia (MgO): It gives the brick a yellow tint color, if present in small quantities.

26.4.2 Fire brick

Fire bricks are very important for high temperature industrial applications. The materials which are capable of resisting high intensity of heat i.e. silica, alumina, magnesite, bauxite and chromate are added in fire brick. The composition of a good fire clay suitable for fire brick is 50-70% silica, 10-25% alumina, 2-2.5% iron oxide or lime magnesia, < 1.5% alkali.

26.5 SAND

It consists of small grains of silica (SiO_2). It is formed by decomposition of sandstones due to weather effects.

26.5.1 Types of sand

Sands available in market are classified based on the source as under.

(i) Pit sand

(ii) River sand

(iii) Sea sand

Based on the size of the sand, it is classified as under.

- Fine sand: It should pass through 1.59 mm opening (suitable for plastering)
- Course sand: It should pass through 3.18 mm opening (suitable for masonry work)
- Graveled sand: It should pass through 7.62 mm opening (suitable for concrete work)

26.5.2 Desired properties of sand

Objectives of mixing sand to prepare mortar are:

- To prevent excessive shrinkage.
- To improve the strength of mortar.
- To improve the setting power. Sand makes the mortar porous, which absorbs CO₂ from air and becomes hard.
- To increase the bulk and thus reduce the cost

The sand used for making mortar should be clean, coarse, hard, free from any clay, dust, mica particles and soft flaky pieces. Sand required for brick work needs to be finer than that for stone work.

26.6 LIME

The use of lime as cementing materials has been made since ancient times, but at present cement has replaced lime to a great extent. Lime is produced by calcinations of limestone.

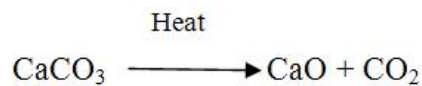

The lime which is obtained by calcinations of comparatively pure limestone is known as quick lime. It is made in kilns. Addition of water (about 32% of CaO) to the quick lime to prepare hydrated lime is called slaking of lime.

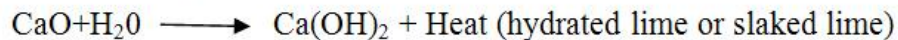

A thin suspension of slaked lime is known as the milk of lime.

26.6.1 Use of lime

- Mortar for masonry work
- White washing
- Purification of water and sewage treatment
- Many industrial application

26.7 Limestone

Limestones (CaCO₃) either in pure or mixed with impurities is the parent material from which lime and cements are produced. Limestone is inert and insoluble in water in its natural condition. When limestone is burnt in kiln or calcined, CO₂ is separated and driven out in the form of gas and what remains is CaO in the form of lumps, called quick lime, which is soluble in water. When water is sprinkled on quick lime, it breaks in to powder, which is Ca(OH)₂ known as hydrated lime. The process is called slaking.

26.8 CEMENT

The ordinary cement was invented by a Joseph Aspdin in England in the year 1824. The inventor took a patent and called it Portland cement as it resembles in its color after setting to a variety of stone found in Portland. The raw materials for cement are (i) lime stone (ii) coal (iii) clay and (iv) gypsum. Cement can be made by two different processes (i) dry and (ii) wet process.

26.8.1 Composition of ordinary/Portland cement:

Lime (CaO) : 62%

Silica (SiO₂) : 22%

Alumina (Al₂O₃) : 5%

Calcium sulphate (CaSO₄) : 4%

Iron oxide (Fe₂O₃) : 3%

Magnesia (MgO) : 2%

Sulphur (S): 1%

26.8.2 Function of cement ingredients:

The properties of cement depend upon its composition, burning treatment and fineness of grinding. Good quality cement should provide strength, binding and water resistant in addition to working, quick setting and plasticity during construction work. The role of different constituents of Portland cement is presented below.

1. Lime: It provides strength and setting property but excessive lime makes the cement unsound and causes the cement to expand and disintegrate. Its deficiency causes less strength and quick setting.
2. Silica: It imparts strength due to formation of dicalcium and tricalcium silicate. The excess of silica improves strength but causes prolonged setting.
3. Alumina: It imparts quick setting property and acts as flux. The excess of it weakens the cement.
4. Calcium Sulphate: This ingredient is in the form of gypsum and its function is to increase the initial setting time of cement.
5. Iron oxide: It imparts color, hardness and strength to the cement.
6. Magnesia: It imparts hardness and color. The excess of it makes the cement unsound.
7. Sulphur: A very small amount of sulphur is useful in making cement sound. The excess of it causes cement to become unsound.
8. Alkalies: The excess quantity causes staining in concrete.

26.8.3 Setting action of cement

When water is added to cement, the ingredients of cement react chemically and form various chemical compounds. The mixture goes on thickening till it achieves a rock like state. It is found that ordinary cement achieves about 70% of its final strength in 28 days and about 90% in one year.

The important compounds formed during setting action of cement are as under.

- Tricalcium aluminate (3CaO. Al₂O₃): It forms within 24 h after addition of water to the cement.

- Tetra-calcium alumino ferrite ($4\text{CaO} \cdot \text{Al}_2\text{O}_3 \cdot \text{Fe}_2\text{O}_3$): It forms within 24 h after addition of water.
- Tricalcium silicate ($3\text{CaO} \cdot \text{SiO}_2$): It forms within a week after addition of water to the cement. It is responsible for imparting strength in early period of setting.
- Dicalcium silicate ($2\text{CaO} \cdot \text{SiO}_2$): It forms slowly and imparts progressive strength.

The above 4 compounds in Portland cement are designated in short as C_3A , C_4AF , C_3S and C_2S respectively.

26.8.4 Types of Cement

26.8.4.1 Rapid hardening cement/ high early strength cement:

The setting time of this cement is the same as that of the ordinary cement. The high strength at early age is due to finer grinding, burning at higher temperature and increased lime content in the composition. This cement costs a little more than ordinary cement. The strength developed by this cement in four days equals that acquired by ordinary cements in 28 days. Thus, it is very important in increasing the speed of construction.

26.8.4.2 Quick setting cement

Under normal conditions, quick setting is considered as a defect, as it does not allow sufficient time for the concrete to be properly mixed and placed. The addition of 3 to 4 % of gypsum is added to the ordinary cement just to retard the setting action. But under certain conditions, when concrete is to be laid under water or in running water, quick setting cement is required. Fineness of grinding and the addition of a small percentage of aluminium sulphate accelerate the setting action. The setting action of such cements starts within 5 minutes after addition of water and it becomes stone hard in less than half an hour.

26.8.4.3 High Alumina cement:

This is manufactured by melting a mixture of bauxite and lime and grinding the resulting clinkers. Total alumina content shall not be less than 32% and the ratio by weight of alumina to lime shall not be less than 0.85 nor more than 1.3. It is not only rapid hardening cement, but has also higher ultimate strength. It gives 6000 psi compressive strength against 2500 psi compressive strength obtained in 7 days for Portland cement. Its initial setting time is more than 3.5 hours and final setting time is 4 to 5 hours as against 0.5 hours and 10 hours respectively in case of ordinary cement. It therefore allows longer time for mixing and placing concrete before it begins to set.

High Alumina cement is immune to thermal shocks and great heat is evolved during setting and hardening. It does not expand on setting. It possesses great resistance to corrosion action of acid and also to high temperatures. Thus it is found very useful in chemical plants, mines, dairies etc. and also for lining the furnaces. It is also high resistant to sea water.

26.8.4.4 Acid resistance cement

The addition of additives like sodium fluosilicate accelerates the hardening process and it increases the resistance to acid and water. It also contains acid resistant aggregates.

26.8.4.5 Colored cement:

The cement of desired color may be obtained by mixing pigments with ordinary cement. The amount of coloring material may vary from 5-10%. The use of chromium oxide and cobalt pigments imparts green color

and blue color respectively while iron oxide and manganese oxide gives brown/red color and black or brown color respectively.

26.8.4.6 White cement

It is prepared without coloring oxides. The process of making the cement is slightly different as coal is not used for burning. White cement is used for fixing marbles, filling of joints in flooring and glazed tiles. It is relatively costly as compared to Portland cement.

26.9 MORTAR

The paste prepared by adding required quantity of water to a mixture of binding material like cement and sand is known as mortar. The proportion of cement to sand varies between 1:2 and 1:6 depending on the use of mortar. It is desirable to use the mortar within 30 minute after addition of water. After setting of mortar, it should be kept damp or wet by sprinkling water to avoid drying of mortar for about 7 to 10 days.

26.9.1 Properties of mortar

The properties of good mortar are listed below.

- Good adhesion with the building.
- Capable of developing required stresses.
- Capable of resisting penetration of water
- Durable
- Good workability-mobility
- Good placeability

26.9.2 Uses of mortar

- Binding material for building materials (bricks, stone etc.)
- Plaster work
- Bedding layer for building units
- Joining of cement pipes, filling of cracks.

26.10 CEMENT CONCRETE

The cement concrete is a mixture of cement, sand, pebbles or crushed rock and water which when placed in the skelton of forms and allowed to cure, becomes hard like a stone. The cement concrete in which steel reinforcement is placed at suitable places to increase tensile stress is called Reinforced Cement Concrete (RCC). The proportion of cement, sand and coarse aggregates varies from 1:2:4 to 1:3:6 depending on the nature of work. As per BIS, the concrete is designated in 7 grades. These grades are M 10, M 15, M 20, M 25, M 30, M 35, M 40 (M refers the mix and number indicates the compressive strength of 28 days in N/mm²). The following points are important for R.C.C.

- < M 15 should not be used in R.C.C. work
- Water-cement ratio by weight should be 0.45 –0.55

- Weight of water = 28-30% weight of cement + 4-5% weight of total aggregate.
- Thickness of R.C.C. work : 80 to 150 mm
- Proper mixing of all materials – using mechanical mixer is very essential.
- Placing of concrete within 30 minutes
- Consolidation using vibrator helps in reducing air bubbles and increases the strength of R.C.C . Hand consolidation which includes ramming, tamping, spading, slicing with suitable tools.
- Provide expansion and contraction joints if length exceeding 12 m.
- Dummy joint – 3 mm width and $\frac{1}{3}$ to $\frac{1}{5}^{\text{th}}$ of slab thickness in depth and it is filled with filler materials.

26.10.1 Curing of concrete

The concrete surface is kept wet for certain period after placing of concrete so as to promote hardening of the mixture. Curing period is about 7 to 14 days. Ponding with water, covering with wet jute bags, intermittent spraying with water etc. may be used for curing.

26.10.2 Water proofing cement concrete

The impermeability of concrete is very essential. If concrete is made dense and free from cracks, it is watertight. This can be achieved by closely adhering the following points.

- (i) Using high class Portland cement
- (ii) Adopt correct proportioning of sand, cement and aggregate.
- (iii) Using clean and non-porous aggregates
- (iv) Proper mixing at optimum water quantity.
- (v) Careful placing, tamping and curing.

Using suitable water proofing compound.

***** 😊 *****

Lesson 27

Building materials – stones, wood, metal, glass etc.

27.1 INTRODUCTION

Selection of building materials mainly stones, wood, metal and glass are very important for dairy plants, because each and every section has its specific requirements. There are different types of stones used for flooring and skirting and it should have desirable properties to with stand to prevailing conditions of different sections. Similarly requirement of type of wood depends on its position in a windows, doors and other applications, soft woods requires seasoning treatment and application varnish and oil paints to prevent yeast and mould growth. Selection of metal depends on type of vessels used for processing, particularly to with stand high pressure and to meet sanitary standards. The glasses used in the dairy are specifically designed with wire mesh inside, so that no glass pieces will fall in the product. In certain sections like, butter, ghee and cheese manufacturing, glasses are used to control sun light particularly UV light to prevent oxidation of fat and related defects in the product.

27.2 STONES

Stones are obtained from rock, a portion of the earth's crust having no definite shape or chemical composition. Stones are used as the construction material for the following.

- Material for foundations and walls of buildings, dams, bridges
- Material for road and concrete making in the form of either broken or crushed stones called aggregates/ gravels/ pebbles.
- Used as thin slabs for paving/flooring.
- Used as roofing tiles
- Lime stones are used as a flux material in the blast furnaces
- In view of several artificial materials developed recently for flooring and roof, the use of natural stone in many applications has become limited.

27.3 Requirements of good structural stones

When stone is used as structural material, the following considerations are to be considered.

(i) Strength: It should be sufficiently strong against crushing. The stones having more compact grains with higher density are stronger. A dense and compact stone has very few or no pores and thus does not absorb water. A stone of igneous origin is stronger than one of sedimentary formation. A crystalline stone is superior to a non-crystalline one and the finer the crystalline structure, the stronger it is. The specific gravity of good stone should not be less than 2.7. It is desirable to have crushing strength of building stone more than 100 N/mm². The crushing strength of some commonly used stone is given below.

- Granite: 75-127 N/mm²
- Sand stone: 64 N/mm²
- Lime stone: 54 N/mm²

- **Durability:** It depends on (a) chemical composition (b) physical structure (c) weathering effects and (d) place or position in the structure. It depends on type of stone and working conditions.
- **Appearance:** The appearance of a stone in relation to the design is of great importance from an architectural point of view. Appearance depends on the color and the ease with which stone can be dressed, rubbed or polished, for which slightly softer stone is selected. It is desirable that the color of stone is uniform, no weathering effect, and free from clay holes.
- **Dressing properties:** The ability of stone for cutting, carved etc is important for building material. In order to perform dressing operations with ease, it should be relatively soft with compact grains. Stone should be homogeneous in texture rather than crystalline. The development of many machines and advancement of technology, the dressing of even hard stone has become quite easy for many applications of stones.
- **Hardness:** It is expressed in terms of co-efficient of hardness. The common accepted norms for various categories of hardness are greater than 17 considered as high, between 14 to 17 as medium hardness and less than 14 as poor hardness.
- **Wear percentage:** If the value of wear is more than 3 percent, then the stone is regarded as unsatisfactory.
- **Seasoning and Weathering:** After quarrying stone should be seasoned for 6-12 months and there should not be any change in various properties. A good quality of stone should not show remarkable weathering effect.
- **Texture:** Stone should be free from cavities, cracks etc.
- **Toughness:** It is expressed in terms of toughness index. The common accepted norms for various categories of toughness are greater than 19 considered as high, between 13 to 19 as moderate toughness and less than 13 as poor toughness.
- **Water absorption:** The absorption of water should not exceed 0.6 % of weight.

27.4 Basis of classification of stones

There are 4 basis of classification of stones as under.

- 1) Geological (based on mode of formation)
- 2) Physical (depending upon structure)
- 3) Chemical (depending on composition)
- 4) Practical (based on use)

27.5 Use of stone

Use of natural stone is various purposes is given below.

- (i) Structure (ii) Face work
- (iii) Paving (iv) Basic material

27.6 Stone Quarrying

The process of taking out stone from natural rock is known as quarrying.

27.7 Artificial stones

- Cement concrete blocks
- Mosaic tiles
- Terrazo

27.8 WOOD:

Wood is of two types – hard wood and soft wood. Hard wood is used for building construction and soft wood is mostly used for packaging material and boxes. Plywood is obtained from inferior quality wood after some processing, and it is used for making furniture. Hardwood is seasoned to reduce moisture content and is also treated with creosote oil. Hard woods are used in the room where moist conditions prevail and it is properly seasoned to prevent any kind of mould growth and contamination. Soft woods are used in the dairy for cold store doors and covered with stainless steel sheet.

Soft wood is obtained from trees of Deodar, Kali, Chir, Pine, Walnut and Spruce etc. Soft woods are resinous and light in color. It is general characteristics that trees having needle like leaves give soft wood.

Sal, Teak, Shisham, Pyngado, Oak, Beach and Ash are some of the examples of hard wood obtained from broad leaf trees. Hard woods are relatively darker in color, heavy, close grained and strong. They are non-resinous.

27.8.1 Timber wood

Timber wood is suitable for building or engineering purposes. When in living tree, the timber is called ‘standing timber’. When trees are cut down, it is called ‘rough timber’ and when it is sawn into various market sizes, such as beams, battens, posts, planks etc., it is called ‘convert timber’

27.8.2 Seasoning of wood

The growing tree contains a large amount of moisture which may be 150% of the dry weight of the timber. The process of removal by drying the excess moisture from the wood in a controlled manner to prevent the shrinkage which occurs, causing cracks and other defects is called seasoning. Seasoning may be natural or artificial. Natural seasoning is best but it takes long time. Artificial seasoning may be water seasoning, boiling or kiln seasoning.

27.8.3 Preservation of wood

Timber is liable to attack by dry rot and other fungi. The function of a preservative is to poison the food matter in the timber. But this poison should not be dangerous to carpenter and must not wash out in rain. The best time to apply preservatives is the early summer. The usual methods of preservation are tarring, charring, painting, creosoting, solignum paints and Ascu treatment.

Tarring consists of coating the timber with hot coal tar. Tarring is adopted only for work of rough character such as timber fences, ends of doors and window frames built into walls.

Charring is adapted to the portions which are embedded in the ground. The ends of posts are charred over a wood fire to a depth of about ½” and then quenched with water. Painting consists of applying 3 or 4 coats of an oil paint. Solignum paints are effective preservatives against attack by white ants. The process of Ascu treatment for the preservation of wood has been developed at the Forest Research Institute at Dehradun. The

powder developed for the purpose is dissolved in water. Six parts of powder are dissolved in 100 parts of water and then applied or sprayed on timber.

27.8.4 Fire proofing

Wood can catch fire very easily and it is difficult to make it fireproof. However, chemicals such as 2 coats of 2% solution of Borax or sodium arsenate are effective in retarding the action of fire.

27.9 METALS

Metals are used in the dairy for different purposes. Mild steel is used for fabrication of sheds, grills, foundations, pipelines, and as structural steel. Cast iron is used for drainage of effluent as well as for the fabrication of various components of machines. Stainless steel is used for fabrication of dairy equipment and milk pipelines.

27.9.1 Stainless steels (SS):

Stainless steels were invented to overcome the problem of corrosion which is a major concern of food and many other industries. The alloy of steel containing iron-chromium-nickel is known as stainless steels which do not rust in sea water and are resistant to acids and several other chemicals. Stainless steels typically contain between 9 and 30 percent chromium and varying amounts of nickel, molybdenum, copper, sulfur, titanium, niobium, etc., may be added to obtain the desired mechanical properties and service life. Having all these properties, SS are widely used in dairy and food industry. Stainless steel is considered noble metal for use in dairy industry. Stainless steels are classified based on the chemical composition and it provides information to overcome many types of corrosion. Some of the limitations of SS employed in food and dairy industry are attack by lactic and malic acids at elevated temperature and poor thermal conductivity. However, these limitations may be overcome by carefully selection & fabrication, optimized operating condition, care and maintenance of the equipment.

27.9.1.1 Classification of SS:

Stainless steels are basically classified as austenitic, ferritic, martensitic, duplex and super-austenitic grades. Each of these main groups contains a number of alloys that are defined according to the chemical composition and specified in European and American international standards. Apart from chromium, the alloy constituents molybdenum, nickel and nitrogen are of great importance to the corrosion resistance. Carbon will always be present to a certain degree, and it is important for the welding properties. In addition, copper, manganese, sulphur, titanium and niobium are used as alloy constituents to impart certain properties. Stainless steel is typical wrought alloy AISI (American Iron and Steel Institution) series designations, includes: 200 (high manganese austenitic), 300 (austenitic), and 400 & 500 (ferritic & martensitic). Martensitic and ferritic steels are magnetic and martensitic steels are typically hardened by heat treatment and are not easily formable. Austenitic steels harden when cold worked. Duplex grades (austenitic/ferritic) are more resistant to stress corrosion cracking than austenitic and are tougher than ferritic grades.

27.9.1.2 Desirable properties of SS :

The properties of stainless steel play an important role in the design of various equipments. The use of high quality SS in fabrication of processing equipments helps not only to prevent corrosion but also ensures purity of food product handled in those equipments. In addition to this, stainless steels are easy to clean and maintain and a number of different products can be manufactured in the same equipment. If properly utilized, equipment made of stainless steel can be expected to last for many years. In selecting austenitic stainless steels, a number of factors other than corrosion performance should be considered. Among these are their usually attractive appearance, good mechanical properties, and excellent fabrication characteristics. On a life-cycle basis, the

alloys are often the most cost-effective. Important characteristic to be considered in selecting the proper type of stainless steel for a specific application are listed below.

- Corrosion resistance
- Resistance to oxidation and sulfidation
- Strength and ductility at ambient and service temperatures
- Suitability for intended fabrication techniques
- Suitability for intended cleaning procedures
- Stability of properties in service
- Toughness
- Resistance to abrasion, erosion, galling, and seizing
- Surface finish and/or reflectivity
- Physical property characteristics such as magnetic properties, thermal conductivity and electrical resistivity
- Total cost, including initial cost, installed cost, and the effective life expectancy of the finished product

27.10 Steel

Steel is an intermediate stage between cast iron and wrought iron. The cast iron contains 2-4 % carbon while wrought iron has carbon content less than 0.15%. In steel, the carbon content varies between 0.25 to 1.5 %. There is no graphite in the steel. The steel becomes harder and tougher as its carbon content increases. Steel is used for various applications in dairy industry.

27.11 Aluminum

Aluminum is used as frame work for doors and windows in dairy and food processing plants. The desirable properties of aluminum which makes it suitable are light weight, softness, and appearance. Its use is limited by the fact that it is tarnished and corroded by ordinary alkaline dairy cleaners and sterilizers.

***** 😊 *****

Lesson 28

General requirement of dairy floors and floors for different sections

28.1 INTRODUCTION

Flooring requirements for different sections of dairy plant has specific needs depending on the type of sections. The flooring of process section has its typical requirement of resistance against lactic acid, alkalies and thermal shocks, this will be met by specific type of stones e.g. mandana stones. The flooring of cold store has specific requirement of non-slippery flooring with hygienic conditions to be maintained, such requirements will be met by semi vitrious tiles. The flooring of RMRD has specific requirement of good mechanical strength, resistance against the detergents, less noise problem etc. The flooring of section for fermented products like, Dahi, Cheese, Yoghurt etc., requires vitrious category of tiles to maintain hygienic conditions. Thus, flooring materials for different sections are selected based on the need of the particular section to meet sanitary standards.

28.2 GENERAL REQUIREMENT OF DAIRY FLOORS

It is necessary to use different types of the flooring material depending upon the use of the flooring surface. One single type of floor in the entire dairy plant is not possible if wear is to be kept to a minimum. Dairy floor requires different types of flooring in order to cope with hazards and other problems of various sections of a dairy plant. It is desirable that dairy floors should impervious, durable and long lasting. The material of flooring should be such that it can be cleaned easily cleaned, non-slippery and cost effective. The flooring is designed considering the effect of washing and cleaning as well as and the ability to withstand changes of temperature by provision of adequate expansion joints.

The provision of adequate fall and drains helps not only to avoid the possibility of water pools but also assists the rapid removal of milk spillage and cleaning solutions. This helps in reducing the corrosion effect to the flooring materials. Normally, the fall should not be less than 1 in 80 for effective removal of liquids. Drainage channels should be at least 15 cm from the wall and drainage channels should not be placed along side walls, as far as possible. Water seepage may cause corrosion of structural steel and weakens the flooring base or R.C.C. Fig. 28.1 shows a cross section of construction of floor.

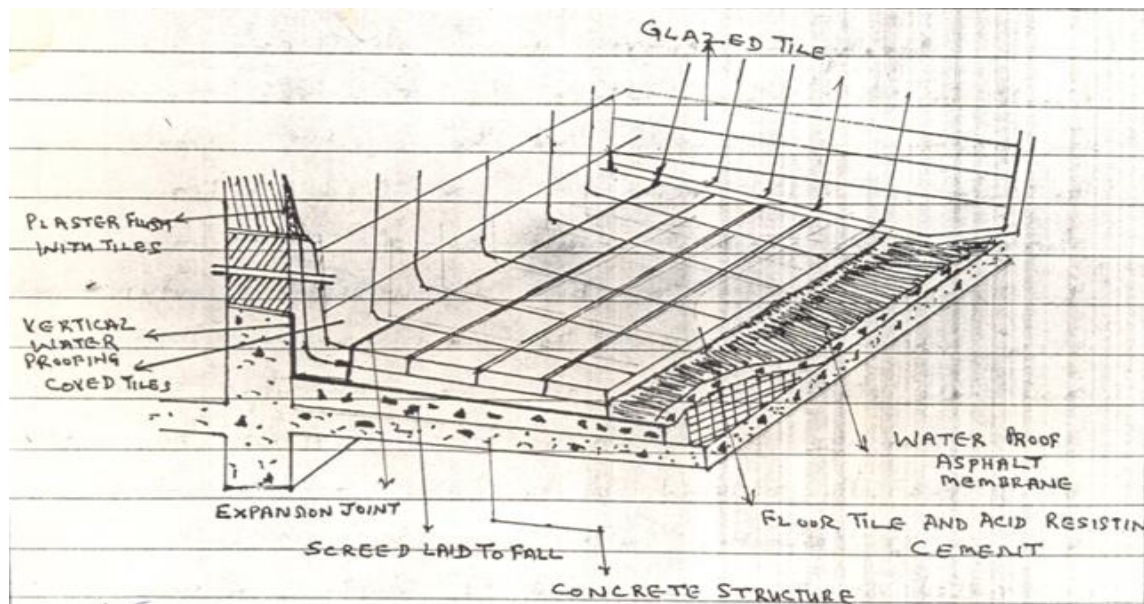

Fig. 28.1 Floor Construction

28.3 STRUCTURAL BASE

The structural base is usually of concrete or R.C.C. A concrete structural base may be cast as a slab directly on the ground/R.C.C. or it may be suspended slab pre-cast concrete units. It should be designed to resist all the static and dynamic stresses with provision of heavy foundation required for installation of equipments. The structural base should be made of good concrete and thoroughly compacted.

28.4 WATERPROOF MEMBRANE

One of the most important features at the time of planning and designing of the dairy floor is the use of water proof membrane in the floor to prevent liquids from penetrating to the base structure. The membrane should be impervious to water, resistant to corrosion, tough enough to resist damage during repairs of the floors and support loads. All joints should be thoroughly sealed to provide a continuous membrane surface. The membrane should be laid to have falls at the base structure and be extended to some distance up the walls. The material used for the membrane must be strong and yet flexible. Acid resistant asphalt laid at least 10-12 mm thick on a layer of bitumen felt is most commonly used. The best results are obtained when the asphalt is laid in two layers with all construction joints broken, i.e. two layers don't have their joints coinciding. Good quality bituminous roofing filled with lap joints sealed with bituminous compounds is also used. Plastic films of polyethylene, polysorbetylene and polyvinyl chloride are also used for the purpose. Properties of water proof membrane are as under.

- Water proof membrane should be impermeable to water.
- It should be resistant to corrosive liquids and substances.
- It should be strong enough to support the required load.

28.4.1 Types of water proof membranes

- Plastic sheet
- Chemicals
- Asphalt or Bitumen layer in the form of a thicker layer which is applied on walls to prevent leakage of water.

28.5 FLOORING MATERIALS

Portland cement concrete is mostly commonly used as flooring material. The floors are resistant to abrasion and alkali. However, it is vulnerable to weak acids and deteriorates under the influence of milk waste.

High alumina cement concrete resists acid solution above a pH 5.0 and is favorable than plain Portland cement. However, it is attacked by weak solutions of alkali and it loses its strength and resistance to abrasion under hot moist conditions. Hence, it is not regarded as a suitable flooring material for dairy plant.

Portland cement concrete often gives good service even where milk spillage occurs provided that regular cleaning takes place to remove the milk wastes. Concrete floor shrink for several months after laying, but subsequently it expands and contracts with variations of temperature and moisture content. Such expansion and contraction may be of the order of 0.05% which may give rise to cracking or curling. Where plain concrete floors are likely to wet, joining gaps of about 12-13 mm (0.5") width should be left open down to the waterproof membrane, and after the concrete has set, they should be filled with asphalt or other suitable joining material. The dairy floors which may be subjected to considerable attrition and abrasion, the structural base should be covered by a topping of more resistant granolithic concrete.

Granolithic concrete contains more cement than ordinary cement concrete and gives good results in dairies, although its surface can be corroded slowly by lactic acids, milk residues and acid detergents. There is no shrinkage after laying concrete tiles which is made of granolithic concrete and cured under controlled conditions. They are laid in cement mortar of ratio 1:3. The joints between 1/8 and 1/2 inches wide must be completely filled with the same mortar. Concrete tiles may be tinted and similarly tinted mortar should be used for the joints.

Ceramic floor tiles can be used for flooring where moderate resistance to wearing is expected. These tiles are resistant to attacks by acids and alkalis. These tiles are available in different sizes such as 6" x 6", 9" x 4.5", 9" x 6", 9" x 9", 12" x 12" etc. These tiles should be thick so as to resist impact damage. Coved tiles should be used at joints between floors and walls. The tiles should be properly laid using appropriate bedding mortar and high grade filling material.

28.5.1 Requirements of a dairy floor or characteristics of a dairy floor

- They should be impervious, smooth and easy to clean.
- It should be able to withstand the effect of lactic acid.
- It should be able to resist the effect of the cleaning solution, steam or hot water.
- It should be strong enough to withstand the effect of falling objects, cans, boxes (impact resistance)
- It should have high resistance to abrasion (wear and tear).
- It should have desired slope towards drains
- In processing section, the slope should be 1:80.
- In bottling section and RMRD, the slope should be 1:40.

28.5.2 Different types of floor:

- Cement concrete floor
- Terrazzo floor used in offices
- Tile floor having either natural stones or synthetic tiles
- Metal floor
- Grill floor

28.6 BEDDING AND JOINTING FOR TILE FLOORS

The optimum result can be achieved by adopting most appropriate way of laying and filling the joints. The materials used for the purpose mainly depend on the type of flooring material used in different sections of a dairy plant. Some of the ways of bedding and joining the floor tiles are given below.

28.6.1 Portland cement

Portland cement mortar is most commonly used for bedding material for fixing floor tiles/stones. Portland cement mortar is resistant to alkalis, but it is attacked by acids and dairy wastes. It is necessary to take adequate care to make water tight joint.

28.6.2 Super sulfated cement

Super sulfated cement is a mixture of ground blast furnace slag, calcium sulfate and Portland cement. It requires special care during hardening after laying. It is resistant to acidic and alkalis.

28.6.3 Rubber latex cements

Rubber latex cements are available for in situ floorings and are based on polyester and epoxy resins. Unsaturated polyesters which in the presence of a catalyst, react with another resin such as styrene, are usually employed for polyester flooring. It is susceptible to attack by alkalis and therefore cannot be used in dairy plants.

28.7 Metal tiles, plates and grids

Metal tiles of two main types.

- 1) anchor steel plates
- 2) cast iron metal tiles

Both types are very suitable to resist impact and abrasion in dairies. They also resist the action of alkalis but they are subject to attack by weak acids.

The anchor plate is usually 12" x 12" size made of 10 gauge steel in the form of a shallow tray of about 7/8" thickness and the wearing surface is punched to give downwardly projected twisted anchors which anchor the plate to the bedding material. For laying the anchor plates, upturned tray is filled with concrete and after inversion it is tamped into position until it is firmly embedded in the concrete.

The cast iron metal steel is made of a square or a right angled triangle, apart from the hypotenuse, the sides of each type are 12" long and the tile is about 1" thick and has a projecting foot at each corner. These tiles are bedded in cement mortar and tamped down until the feet rest firmly on the structural base, so that the stresses on the tile are transferred evenly to the structure.

Metal plates are used frequently on dispatch docks and in cold stores to provide very durable wearing surfaces over concrete flooring. Metal grids are sometimes incorporated in floor surfaces as reinforcement against abrasion and are embedded in the topping so that the upper side of the grid is flush with the floor surface.

28.7.1 Cast iron grill floor

Cast iron tiles have a hollow honey comb-like structure which gives a strong surface and has no slipperiness. This type of tiles has no problem of looseness from concrete surface. It gives less noise than metal tiles when cans are moved over it. This floor has high impact and abrasion resistance. Some time, concrete part of cast iron grill floor may be eaten away due the action of h milk or acid. .

28.7.2 Cement Concrete Floor

The general construction includes a structural base of RCC or concrete, a screed laid to fall, a water proof membrane, a bedding mortar and a top finishing surface or layer or a wearing surface.

28.7.3 Curing of concrete:

Curing of concrete is necessary to increase the strength and water tightness as cement reacts with water at a slow rate and it then becomes hard. The aggregate then formed has no reaction but it forms a strong bond and fills in the pores. Normally the structural base is 10-15 cm thick. Concrete of dairy comprises cement to sand to aggregate in the ratio 1:3:5.

28.8 Bedding mortar:

The layer of the bedding mortar is generally kept around 2-3 cm thick. It has a ratio of cement to sand as 1:3. Its function is to give attachment to the top surface.

28.9 TERRAZZO FLOOR

It is similar to concrete floor, and is generally used in offices, labs and such other places where decorative effect is required. Before hardening the top surface, marble chips of irregular shape are fixed on the upper surface and pressure is applied so that the marble chips get embedded on the wet top surface of the cement floor. After hardening, the surface is finished smooth so that the marble chips fixed on the top give a good appearance. Colored cement may be used to impart better look. Its main limitation is that it cracks when it comes in contact with hot and cold water due to thermal expansion and contraction.

28.10 TILE FLOOR:

Two types of tiles can be used viz. natural stone or synthetic (artificial) tiles.

28.10.1 Natural Stone or Kota Stone:

It is obtained from quarries and is then cut to the required size. They are available in different colors like red, buff, light green, brown and yellow. Acid resistant Kota stone (popularly known as *Mandana* stone) is also available, which can be used in the dairy industry. In order to be used in the dairy plants, the stone should have a minimum thickness of about 3 - 4 cm. They may be square or rectangular and should have a 90° angle edges. The top surface should be polished and the bottom is kept unpolished to get better gripe with bedding mortar.

28.10.2 Concrete or Cement Tiles/ Artificial Tiles

These tiles can be made by making the desirable size mould using mortar and then hydraulic pressure is applied to make it non-porous and stronger. Marble chips of different colors may also be included in this type of tiles. Cement may be high alumina cement or colored cement. The size of the tiles may be 12" x 12", 18" x 18" etc. These tiles are cured in water for 5-7 days and subsequently laid on bedding mortar. Various types of grinders

are employed for surface finish of the floor. These types of tiles are rarely used as many other varieties of tiles are available.

28.11 Maintenance of floors

The following points should be considered for the maintenance of the floor of different sections of dairy plant.

1. Regular cleaning dairy floors is essential for hygiene, safety and long life of floor.
2. All the joints should be carefully observed for any water/milk/chemical penetration through the joints. Seal the joints using cementing material, if any defect is noticed.
3. Remove milk/waste water etc. from the floor in order to cause insanitary or slippery conditions.
4. Floors soiled with oil should be cleaned by scrubbing with detergent and water.
5. Lactic acid are formed as milk sours, therefore, early removal of spilled milk is desirable.
6. Use appropriate chemicals or combination of chemicals for floor cleaning. Don't sprinkle chemicals on the floor as it may damage the floor surface. Use mild detergent solution with low free sulphate is recommended for floor cleaning.
7. Hand scrubbing with brushes or electric scrubbing followed by rinsing with clean water is recommended.

***** 😊 *****

Lesson 29

Structural Aspects of Foundations, Roofs, Ceilings, Walls, Doors and windows

29.1 INTRODUCTION

Structural aspects of dairy building are very important as it is necessary to design the plant considering strength and vibrations of machines. The design aspects of roofs, ceilings, walls etc. are carefully designed to maintain required hygienic conditions in the plant. The basic principles of design of dairy building are the same as that of normal factory building. Adequate care is necessary to consider sanitary aspects while designing and selecting building materials.

29.2 FOUNDATION

Foundation of building should be strong enough to support super structure and to resist vibrations and impact load of heavy machineries. The design of foundation depends upon the nature of structure which they have to carry and the properties of soil the soil. The structure may consist mainly of load bearing columns/walls which are required to support the structure. It is necessary to work out the total load to be supported. The actual design of foundation is based on these aspects as well as the quality of sub-soil.

29.2.1 Traditional strip foundation

This is the most usual variety and consists of concrete say 9 inches thick laid at the bottom of the trench 3 feet deep. The width that the concrete extends beyond the faces of the wall depends upon the bearing capacity of the soil. It is necessary to follow standard guidelines to decide the width of the concrete. These aspects depend on the local soil conditions as well as factor of safety to consider in the design of the building. It is not possible to generalize the design aspects of foundation. There are regions where the traditional foundation with load bearing wall is not recommended owing to soil conditions reveling in that area. Column and beam type of structure may be required to support the load and other stresses.

29.2.2 Stepped foundation

The foundation of building should be strong enough to support the superstructure. The size of foundation is governed by its depth and width which are determined by the soil type and load acting on it. The size of the foundation should be determined on the basis of bearing pressure of the soil in which it is built.

A typical section of stepped foundation for 13.5 inch thick wall is shown in Figure 29.1

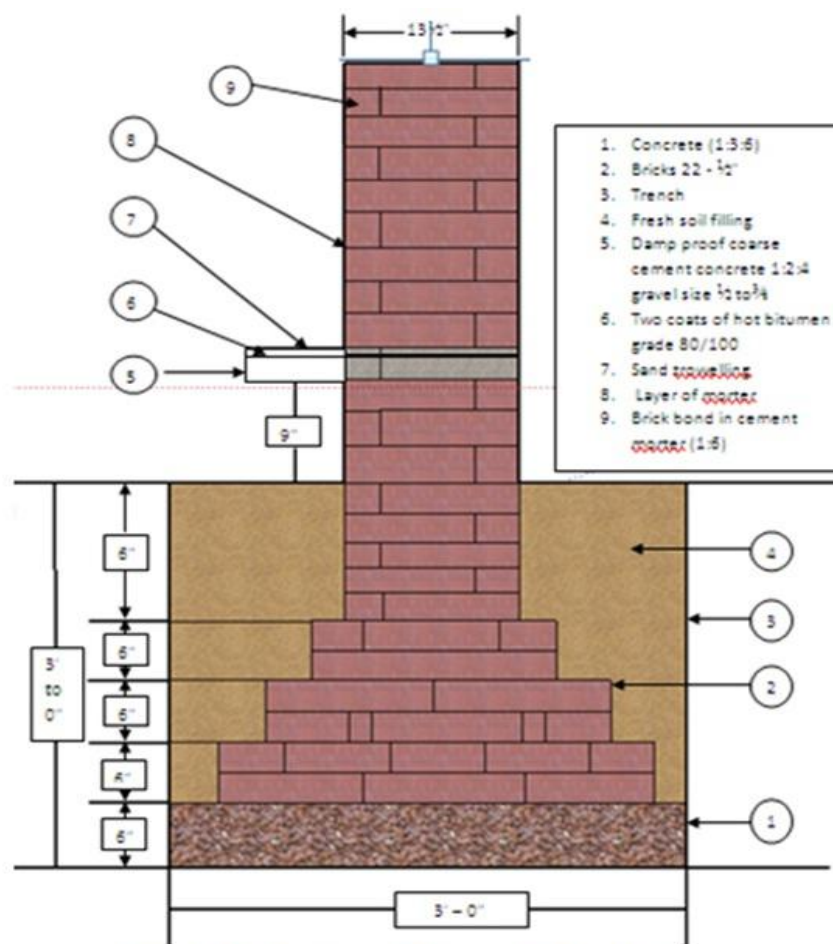

Fig. 29.1 Section of stepped foundation

29.3 WALLS

Walls for plant buildings are made of brick, concrete, concrete block, aluminum and glass. Bricks are widely used for the construction of walls. It is relatively cheaper and proper plastering and painting makes the walls quite water proof. In many sections, glazed tiles are laid up-to the height of 7 feet or more for ease of cleaning. With adequate care, repairs can be made without spoiling the appearance of the building.

Concrete walls are relatively costly and repairing is difficult. Provision is necessary to tackle the need of unsightly repairs. Aluminum partition walls can be made using flat panel construction or corrugated sheets. Glass panels used in building give good lighting but it is essential to keep the glass surfaces clean.

Walls which are made up of brick or stone are mainly two types.

- Partition wall: To divide an area into two or more compartments or cabinets, etc. The width of partition wall using standard brick is about 4".
- Load bearing wall: Walls which can take loads of structure of ceiling or of superstructure. The width of the load bearing wall using standard brick is 14" or 9".

29.3.1 Construction of brick walls

The dairy buildings are of two types namely single or two storey building having load bearing walls. Another type of building is having column and beams which supports the entire load of the building. The load of the building is transferred to the soil by beam and columns. It may be multi-storied building or even single storied building. In this case, walls are simply dividing the area in to different portions/sections. The strength of wall is not much important as the entire load is taken by beams and columns. If the size of room is small in case of load bearing structure, beam is not required. The external walls take the load and transfer it to the soil. In construction of walls using bricks, it is desirable to staggered the joints. Mortar of suitable proportion of cement to sand ratio is recommended for different types of walls. Optimum quantity of water is necessary in the mortar for proper spreading and setting of plaster.

29.3.2 Surface finishing for walls

Plastering using cement to sand ratio of 1:2 or 1:3 is used for surface finish of walls. The plaster is generally applied in two coats (1) floating coat and (2) finished coat. The floating coat of the plaster is 1.5 to 2.0 cm thick. The main purposes of plastering are as follows.

- To hide irregularity of walls (grooves)
- To avoid unevenness of wall during construction
- To improve the appearance of the wall
- It provides or facilitates the application of suitable paint
- It also prevents deterioration and protects the wall from external atmospheric effect.

Ceramic glazed tiles/vitrified tiles are also used for the purpose of wall finish.

29.4 Ceramic/Glazed Tiles

Glazed tiles are laid up to the height of 2 m in the processing room and other sections of dairy plant. The use of glazed tiles provides a surface which can be easily cleaned and hygienic conditions can be maintained. These tiles also make the wall waterproof.

29.4.1 Classification of Tiles

- **Non – vitreous:** Non-vitreous tiles has a high degree of moisture absorption greater than 7% of the weight of the tiles. Even though, it does not prevent the tiles from having high degree of strength and it also facilitates installation because of their adherence to the mortar.
- **Semi-vitreous:** These tiles have a high density that limits the moisture adsorption to 3-7% of the weight of the tiles.
- **Vitreous:** These tiles have a moisture absorption of 0.5 to 3.0%.
- **Impervious:** These tiles are the hard and their moisture absorption is less than 0.5% and they are readily cleaned off stains and dirt.

In lower portion of the wall of RMRD and cold store, damage may occur. Skirting is provided in the processing room to make lower portion of the wall hard. Bumper rails in cold store and railing on the walls are provided to prevent the damage due to crates/cans. Wherever walls are not covered with tiles, they are plastered and painted. Use of good quality paint is recommended for painting of walls.

29.5 Doors and windows

Doors and windows are subject to grueling condition existing in milk plant. The door of stainless steel is the best choice in many dairy plants. Hard wood or water proof plywood may be used for making doors and

windows. Aluminum or aluminum alloys can be used but the alkaline cleaning materials which are used in milk plants may spoil the surface. Doors of ordinary steel sheet on a steel base are sometimes used, but in such cases, the whole door must be galvanized or protected against corrosion.

Plastic sheet can be used with a wooden or metal frame. There are many options available for the selection of doors and windows. It depends on the requirement, cost, maintenance etc.

Doors for cold rooms must be thermally constructed from timber/PUF panels and cladding of S.S. may be used for protection of insulation. All door fittings should be of rust proof material and of robust construction, particularly in case of swing doors. The locking mechanism for cold store room doors must always be such that it can be operated from inside the cold room.

29.5.1 DOORS

The provision of doors in a building should be carefully made considering the movement of materials, persons, location of door, size requirement, type of door etc. The height of the door should be more than 2m inside the frame. Regarding the width of the door, it should be designed for the particular requirements. Usually, it varies from 0.75 m to 1.5 m depending on the type of the room. When the width is more than 1 m, double shutters may be used. The normal height of door is 2 m but it may be more in case of workshop, boiler room and garages. A rolling shutter may be used for large size doors especially in boilers, garages and workshop. The number of doors depends on the type of room and size of the room. Hardwood or laminated plywood may be used for preparation of doors. Wood or plywood doors should be protected from moisture and water by painting.

25.5.2 Types of doors

- Ledged door
- Ledged and braced door
- Frame and ledge door
- Frame and paneled door
- Louvred door
- Flush door
- Door without hinges
- Sliding door
- Rolling steel door
- Collapsible door
- Revolving door

Flush doors are manufactured in standard sizes to facilitate mass production. It consists of a skeleton or hollow frame of rails and stiles covered with plywood or any other type of reconstructed wood. Louvered doors maintain free flow of air and also maintain privacy. The door without hinges such as sliding door, rolling door etc. are used in large size doors.

25.5.2 WINDOWS

The purpose of providing windows in building is to get ventilation and natural light. Openable windows provide both air and light, while non-open able windows provide only light. The size of window and its location are very important to achieve optimum advantage. In deciding the location of windows cross ventilation is kept in mind for office building. Fixed glass windows are also provided in dairy building to get natural illumination. It is recommended that

1/10th of the floor space is allowed for the window, of which one half should be capable of opening, when required. Another thumb rule adopted is that window area is equal to the square root of the cubic contents of the room.

The exact location of the windows depends also on the purpose for which the room is used. For example, in an ordinary living room, the sill of the window should be kept at about 2.5 feet over the floor level while in bathrooms or a lavatory. The window will be kept at a higher level, so that even when the shutter is open, there should be privacy to the occupant. The window sill should be at a height of about 0.8m height from the floor. The height and width of the window depends on the type of window and number of windows. Entry to dust and insects should be prevented in the product processing room by providing a wire mesh. Total window area may be 20-25% of floor area.

25.6 ROOFS AND CEILINGS

The use of R.C.C. is widely used for roofs and ceilings. The R.C.C. is designed and executed properly to prevent leakage of water. Water proofing work is necessary to eliminate the chances of water penetration in the R.C.C. Use of good quality materials and proper workmanship during R.C.C. work is necessary to get better result. It is necessary to carry out curing of R.C.C. immediately after setting of the R.C.C. White ceramic/glazed tiles may be laid on the terrace to reduce the heating effect and to make the R. C. C. water proof. It depends on the local weather conditions to decide the need of water proofing requirements.

Slope is provided on the top to facilitate drainage of water. The thickness of the slab varies from 10 cm to 15 cm depending on the size of the room and other structural considerations. Height of processing section is more in order to facilitate the service pipelines.

Roofs are classified as flat, semi-steep and steep depending on the slope provided. Flat roofs have rise from zero (level) to 8 inches per horizontal foot. The rise in semi-steep roofs varies from 3.25 to 12 inch rise per horizontal foot. The rise of steep roofs varies from 13 to 24 inch rise per horizontal foot. In many factories and food plants roofs are generally flat or semi-steep type.

The roof sheet of different materials such as PVC, fibre glass (FRP), polycarbonate etc. in various design are available for making roof of factory. These materials have advantage of light in weight and color choice based on the requirement of the plant. Construction of a satisfactory roof is possible only when high standards are maintained during all phases of its construction. The selection of material for roof mainly depends on the weather conditions of the place. There are options available to select the best possible roof for the plant. Ceilings of the dairy plant must be smooth and impervious so that it can be easily cleaned and maintained. In the plants where air ducting is necessary, it is carefully planned with false ceiling of appropriate material.

***** 😊 *****

Lesson 30

Drain and drain layout for small and large dairies

30.1 INTRODUCTION

The ratio of milk to water used in various dairy plants varies from 1:1 to 1:3 depending on the type of plant. The old figure of water use was quite large but now water conservation measures resulted in to considerable low level of water consumption. Water is mainly used for washing of equipments, floors, milk crates/cans, hot water, chilled water etc. When water is used in dairy plants, it is necessary to provide drains and piping arrangement to transfer the waste water to effluent treatment plant (ETP) of the dairy. The drains and pipeline layout should be such that it maintains hygienic conditions in the processing area and waste water containing milk residues is efficiently collected from all the sections and finally supplied to the ETP plant.

30.2 DRAINAGE SYSTEM FOR DAIRY PLANTS

Drainage system is very important in dairy plant. Therefore, it is one of the essential considerations at the stage of planning and design of dairy building. It is important to provide adequate numbers of sanitary drains coupled with waste water conveying system to transfer the effluent to the treatment plant. Any shortcomings may lead to choking of drainage pipelines and unhygienic conditions in the plant. Cast iron or PVC pipelines are commonly used for conveying of effluent in dairy plants. The planning and lay out of the drainage system is done in such a way that it is possible to separate high BOD and low BOD effluent. This is necessary to adopt different methods for the treatment of effluent. Anaerobic method of treatment of high BOD effluent is getting considerable importance in dairy industry as its operating cost is low and it generates methane gas which can be used for boilers. The following points should be considered while planning and laying of drainage system.

1. Select the most appropriate type of drains and entire system considering hygienic conditions.
2. Use the drains which can be cleaned easily.
3. Provide adequate number of drains considering the maximum flow of water.
4. Use of 4"-5" (100 mm to 125 mm) diameter pipe for drainage lines for handling milk plant wastes.
5. Regular cleaning of sanitary drains is recommended to avoid choking of drainage system.

30.3 FLOOR TRAPS FOR DAIRY FLOORS

A trap is a device which is used to prevent sewer gases from entering the processing area of the building. The traps are located below or within a plumbing fixture and retains small amount of water. The retaining water creates a water seal which stops foul gases going back to the processing area of the building from drain pipes. A good trap should maintain an efficient water seal under all conditions of flow. In Gujarat, sanitary trap used in large capacity dairy plant are popularly known as Amul trap (drain) which is fabricated using 2 mm thick stainless steel and is available with the sanitary design for dairy and food industry. These are available in various specifications and finish based on the need of industry.

Drains for dairy plant floor may be square type or round type. A trap is placed beyond or underneath the drain. A typical floor trap is given in Fig. 30.1 which has two cast iron cover plates, the lower one perforated and the upper one slotted. The top plate retains big size materials such as bottle caps, threads, glass pieces etc. while lower perforated plate retains relatively smaller size materials. The debris retained on these plates can be

removed.

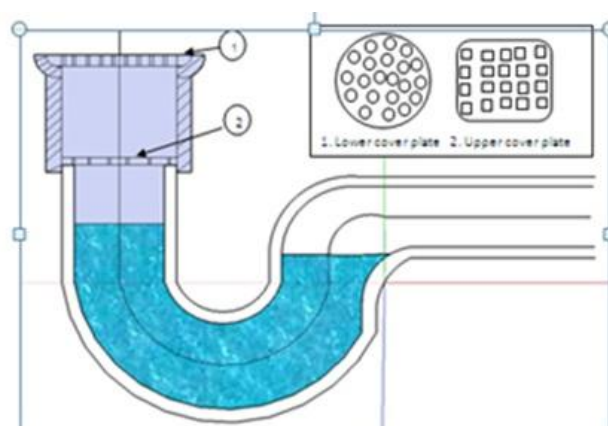

Fig. 30.1 Floor trap with cover plates

30.4 DESIGN CONSIDERATION FOR DRAINAGE SYSTEM OF DAIRY PLANT

The efficient collection of the effluent from all the sections of dairy plant and conveying of the effluent are two important considerations for the drainage system of dairy plant. There are two categories of drainage system.

1. Drainage system for different sections of dairy, laboratories,

2. Storm water drainage system for collection of rain water from roof, surface water from paved areas. This water is quite clean and can be handled for useful applications such as water re-charging of wells/tube wells. The system consists of big size cannels and cement pipelines of big diameter, pumping etc. This system of rain water management is also very important in order to eliminate water accumulation in the dairy premises.

In this lesson the main emphasis is given for the drainage system for different sections of dairy plant. This system is continuously in use throughout the year and hence adequate attention is required to design and laying of the system. Some of the important points to be considered are indicated below.

- Floor in the processing section should be laid with adequate fall so that water runs quickly to drain. This is also important to extend the life of the floor. The minimum slope should be 1:80 and slope up to 1:40 is considered better from point of view of drainage. The recommended slopes in floor towards drain for processing room is 0.25 inch per foot and 1/8th inch per foot for cold store. The probable places where spillage of milk may occur. The slope should be arranged in such a manner that liquids will flow to the drain by the shortest route.

- The arrangement of drains in a large processing room is shown in Fig. 30.2. In this layout, the entire floor of the large milk processing unit is divided into 8 segments and 8 floor traps have been placed to catch liquid flow from the floor segments. Liquid falling on any of the segments will quickly move towards nearest trap. Drains underneath the traps run in straight lines as shown in Fig.30.2 and meet the main drain line which later joins the main sewer line. This type of layout is highly recommended for large milk processing rooms. For small processing rooms, this type of arrangement may be provided on the side of the wall keeping about 30-40 cm distance from the wall.

Use vitrified salt glazed clay/concrete/PVC sewer pipeline to transfer the dairy effluent to treatment plant.

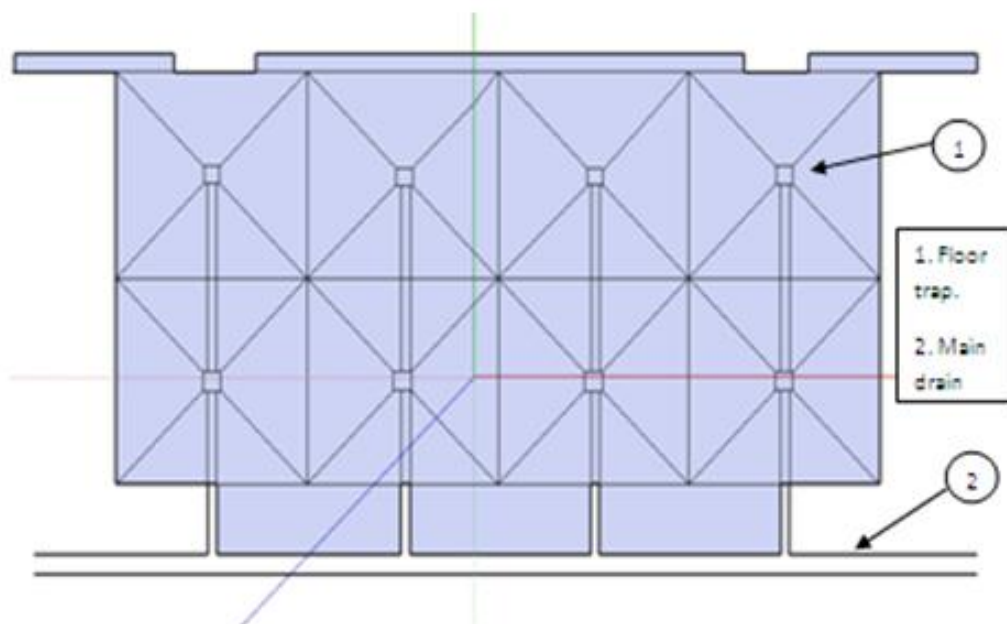

Fig. 30.2 Drain layout of a large milk processing room

***** 😊 *****

Lesson 31

Ventilation, Illumination and fly control

31.1 INTRODUCTION

The circulation of air in different sections of dairy plant is very important to maintain better quality of air inside the plant. It is also necessary to provide adequate level of illumination in different sections as well as at specific location of the section in order to carry out different operations with safety of workers and inspection of the operations. The control of fly is very essential to maintain sanitary conditions and to meet safety standards for various products.

31.2 VENTILATION IN DAIRY PLANT

The term ventilation refers the circulation of air in order to maintain quality of air in the plant. The ventilation system includes supply of fresh air and removal of fumes, heat, dust, toxic gases and undesirable odours. Efficiently designed ventilation provides adequate quantity of fresh air of standard quality. In dairy plants, large quantity of water, cleaning solutions, hot water and steam is used for various purposes. Vaporization of water and flash vapour produced in different sections are causing to increase the relative humidity of the air. Higher level of relative humidity is not desirable as it creates uncomfortable conditions for the persons working in the plant. For human comfort, relative humidity of 60-65% and air temperature of 22-24⁰C are desirable for majority of people. It is reported that each person requires about 0.5-0.75 m³ of fresh air per minute for breathing. The comfort condition is difficult to obtain in a fluid milk plant without providing effective control on the quality of air. Higher humidity is also responsible for corrosion and growth of molds. It may be noted that it may not be possible to achieve desirable condition of air only by ventilation but it may be necessary to use air conditioning system to achieve optimum quality of air in the plant. Ventilation is important in dairies from point of view of sanitation as well as quality of the products. The quality of milk and milk products are adversely affected by odors absorbed in poorly ventilated rooms.

31.2.1 Objectives of ventilation

- To provide requisite quantity of oxygen by way of fresh air
- Removal of ventilated air
- Circulation of fresh air in room
- Maintenance of necessary level of RH
- To maintain proper temperature of room
- To eliminate dust, odor, smoke, etc from the air
- To remove any pathogenic and other bacteria that might be present.

31.2.2 Methods of ventilation

The conventional methods such as providing windows for cross ventilation, opening of doors, windows and using electric fans are not adequate in dairy plants. These can serve the purpose in small rooms and the sections where generation of water vapour is very less. Therefore, ventilating equipments are required to be installed for replacement of air in large food processing rooms. This can be achieved by providing ceiling ventilators or ventilating sash or ventilating skylights. Ventilation for milk receiving room, can washer area, crate washer section etc. requires special considerations as water vapour generated in these sections is very high. A large quantity air replacement with control is necessary for these sections depending on the size of the section. Thus,

the purpose of efficient ventilation is to remove stale air containing excessive water vapour. The number of air changes desired (i.e. number of times the volume of the air of the room is changed by fresh air per hour) types of processes, environmental conditions and number of persons working in these rooms. The methods used for ventilation can be classified as under.

1. Natural ventilation

- Difference in temperature between the air inside and outside
- Pressure difference caused by the wind

2. Mechanism ventilation

- Simple input and/or output fans
- Plenum ventilation systems

Sensible heating or cooling of air changes the relative humidity of air. The problem of higher humidity is the major consideration in design of efficient ventilation. The knowledge of psychrometry is important in order to measure and monitor the quality of air. The use of different types of air filters followed by suitable air processing/replacement is necessary for optimum result. These aspects are important at design stage of the plant so that location of windows and mechanical system can be accommodated in the plant. The purpose of mechanical ventilation system is to provide large quantities of air changes. It gives 10-15 air changes while normal ventilation gives 4-5 changes. The problems associated with plenum ventilation are the noise and improper distribution of air. It is desirable air should be distributed without producing excessive draft with minimum possible noise level. In large sections many diffusers are installed on the ceiling/wall to distribute the air without producing excessive draft. Rectangular or circular air duct with flow control dampers may be used in specific requirement of the plant.

1 air exchange = total cubic meter of air in the room

Total number of air changes is the number of times the total volume of the room exchanged per hour. For example, if the number of air changes is 10, it means that the total volume of the air of the room is changed 10 times in one hour time.

31.2.3 Maintenance of Ventilating Systems

1. Cleaning, removal of dirt and dust as well as and painting of ventilating sash, ventilating skylights and ceiling ventilating at regular interval.
2. Regular cleaning of fans and blower blades is important for efficient operation. Dust and dirt deposited on the blades of fans and blower may cause unbalancing which may result into vibration and noise. Maintenance should be done carefully so that blades are not damaged.
3. Filters used in the system are to be cleaned on regular basis considering the quality of air and type of filter
4. Wherever corrosion noticed at fan housing or any part of the system, it should be wire brushed and painting is done using antirust paint.
5. The totally enclosed motor should be kept free from lint, dust and paint in order to maintain better heat transfer to cool the motor.
6. Check the electrical connections at regular interval.

31.3 ILLUMINATION

Lighting has played very important role in industrialization as it has reduced the difference between day and night conditions to carry out various operations. Dairy plant operates during day and night time to process the milk and to manufacture different products. Proper level of illumination is important for reducing the strain on the eyes of workers and providing safe working conditions in the plant. Selection of most energy efficient lighting system for various sections is very important in dairy and food plants. A well designed, energy efficient lighting system can mean higher lighting levels and lower energy costs. It is possible to reduce energy costs by making small changes to the lighting system. The terms used in connection with illumination are explained below

Illumination usually refers to energy radiated in the visible spectrum from 0.38 to 0.70 μ wave length. Illumination is important in the processing plant from the standpoint of visual operation, safety, cleanliness, inspection and color recognition. Bright light should not be defined as good illumination, because it may cause pain in the eyes. A good illumination is defined as illumination which produces no strain on eyes.

31.3.1 Requirements of good lighting

1. Enough light for all visual tasks
2. Proper distribution and diffusion of light
3. Absence of glare

Wall and ceilings should be painted in light color, not only to minimize the contrast between work and surroundings but also to give maximum results from illumination. A window area equal to 20 % of the floor area is suggested where dependence is placed upon natural light.

To fulfill the requirement of proper illumination, light should be well diffused without flickering. To achieve optimum result, background ceiling should have a minimum reflectance of 75 % and side walls from 50 to 65 % and the floor a reflectance of about 20%. The reflectance of the floor, walls and ceiling with a given light depends upon the roughness and color of the surface. A dark color will absorb more light, giving a lower reflectance, whereas a light color reflects a large portion of the light. The illumination in a milk plant should be such that the work can be done accurately, with speed and ease without straining the vision of the employees. It is necessary to understand the following terminology to select the most efficient source of light.

- Lumens: It is a measure of light output from a lamp. e.g. 40 watt (W) incandescent bulb produces about 13 lumens per watt (13 lm/W).
- Lux or Foot-Candle: The light level at the working surface is measured in lux or foot-candle (fc). [10 lux =1fc]. e.g. Outside illumination level in summer will be around 80,000 lux or 8,000 fc.
- Average Rated Life: The average time it takes for 50% of light bulbs to fail is called average rated life.
- Color Rendering Indexes (CRI): The ability of light sources to render colors the same way sunlight does is called CRI.

It is necessary to get maximum lumens per watt to reduce energy costs for illumination. Typical lumen outputs are shown in Table 31.1

Table 31.1 General Characteristics of Light Sources used for lighting

Lamp Type	Lamp Size (W)	CRI	Efficiency (Lumens/W)	Typical Lamp Life (h)
Incandescent	25-200	100	11-20	750-5000
Halogen	50-150	100	18-25	2000-3000
Fluorescent T8 (4 ft)	32	75	88	20000 -22000
Fluorescent T5 (4 ft)	28	85	104	20000
Compact Fluorescent	5-57	80-90	50-80	10000
Metal Halide	35-70	60-80	60-94	7500-10000
High Pressure Sodium	35-400	20-80	63-125	15000-24000
Light Emitting Diode	1.2-1.4	70-90	16-53	60000-100000

31.3.1 Types of Light

31.3.1.1 Incandescent

Incandescent lamps are not energy efficient as shown in Table 31.1. Incandescent lights also attract flies and other insects and are quickly coated with dirt that further reduces the amount of light available. These lamps have relatively short rated life.

31.3.1.2 Fluorescent

Fluorescent light should be the main light source in dairy plants. Fluorescent light is very energy efficient compared to incandescent bulbs. It has long rated life and gives good quality light and Lumens/W is very high. There are 2 types of fluorescent systems used in industry namely compact and tube fluorescents. Fluorescent tubes are available in a variety of lengths and diameters.

Advantages of fluorescent lighting are given below.

- Fluorescent lighting takes less energy to provide the desired level of light.
- Fluorescent tube lamps last 20000 h
- Conversion from incandescent to fluorescent will reduce energy usage by up to 75%.

Fluorescent typically has a payback time of less than 2 years.

Table 31.2 Power consumption and light output of incandescent light bulbs and compact fluorescent light bulbs

Incandescent Light Bulbs		Compact Fluorescent Light Bulbs	
Watts	Lumens	Watts	Lumens
25	270	5	250
40	510	7	400
52	780	9	600
60	860	15	900
90	1,540	18	1,250
100	1,680	26	1,800

31.3.1.3 Light Emitting Diode (LED)

Light Emitting Diode or LED systems are not yet used in commercial factories. Research is required to ensure this technology for various applications. Energy efficiency of LED lamps can be very high (50 lumens/W) and life is much longer (up to 100,000 h) than other light systems. If the technology can be adapted for barn environments, it is expected that LED lighting systems will provide large on-farm energy savings in the future.

Advantages of LED are as under.

- Environmental friendly-energy efficient with 1/5th of the power consumption of incandescent lamps.
- Long life - LEDs lasts up to 100,000 h compared to incandescent bulbs at 1,000 h or 20,000 h fluorescent lamps
- Low maintenance cost
- Miniaturization - small size allows them to be used in areas not easily accessible
- High reliability - LEDs are solid-state devices, without moving parts, glass or filament to break. They are robust and vibration proof.
- Fully dimmable
- Multicolor - available in all colors
- High speed response - immediate response, no preheat or starting time required.

31.4 FLY CONTROL BY AIR CURTAIN

Air lock: It prevents contact of external air to internal air of cold store, it works as buffer. Its temperature is higher than the temperature of cold store and less than the temperature of external air. Air lock requires some space and at that space we cannot store the product.

Air curtain: Blowing of air at certain velocity with the blower producing air to prevent the entry of air from outside the door is called air curtain. Air lock system is not suitable if it is required to open the door frequently. Air curtain is a stream of air at usually certain velocity blown down it to prevent direct entry of external air. Its advantages are:

- It controls the temperature
- The door can be kept open
- Control of dust and flying insects

***** 😊 *****

Lesson 32

Paints, coatings and mold prevention

32.1 INTRODUCTION

The purpose of painting is to protect the building and engineering materials from corrosion and rusting. This will greatly enhance the useful life of the building and equipments. Painting and coatings also decorative look to the building. The selection of appropriate paint and coating material is very important to get optimum result. The control of mold growth over the building and other parts of walls, ceilings, cold storages etc. is one of the essential requirements in dairy and food plants.

32.2 PAINTINGS

The objectives of painting are as under.

- It protects the surface from weathering effects and effect of other gases and fumes.
- It prevents decay of wood and wood based products.
- It prevents corrosion in metals used in dairy plants.
- It gives good appearance to the surface.
- Painting makes the surface smooth for easy cleaning.
- It makes the surface hygienically good, clean and attractive.

Paint is made of two broad components pigments or solid powders and vehicles (carriers), which transfer the pigment onto surface. Paint consists of base material, carrier, drier, coloring pigments and solvent. A base is a solid substance in a fine state which forms the bulk of paint. It forms opaque layer over the surface of the material to be painted. Vehicles are the liquid substances which hold the ingredients of paint in liquid suspension. Paints and other protective coatings deteriorate rapidly in dairy plants because of constant exposure to moisture, acid, alkali and high humidity. Painted surfaces showing evidence of deterioration must be attended immediately to maintain coating of the paint on the surfaces. It is noticed that break in color film may cause similar failure surrounding the area. If timely maintenance is not carried out, then hygienic conditions will be adversely affected. It is possible to extend the life of painted surface inside the plant by minimizing condensation of steam/water vapour by installing mechanical ventilators.

Adjoining rooms at different temperatures differ in vapour pressure which causes moisture migration from one room to another. Under such conditions, moisture may penetrate the paint film on the colder surface. In order to minimize this effect, the wall of the warmer room must have an impervious paint film to provide a vapour barrier.

The surfaces to be painted should be cleaned and dried before applying paint coating. Apply rust inhibiting primer on bare unpainted steel before applying color coating. If previously painted surface is to be repaired, clean the metal surface by using wire brush and then apply the color. Concrete and plastered surfaces should be thoroughly cleaned by means of wire brush to remove loose paint before applying new paint.

Dairy products readily pick up solvent fumes from paint and therefore, it is necessary to avoid brushing or spray painting in room containing milk or milk products. During painting, every effort should be made to provide the best possible ventilation both to minimize product contamination and to reduce the nauseating effect of the paint fumes on the painters. Ventilation should be continued until the paint is dry and the room is free of solvent fumes.

32.3 Characteristics of ideal paint

The following are the ideal properties of paint.

- Good spreading power
- Low cost
- Ease of application
- Drying in reasonable time
- Form hard and durable surface
- No effect on the health of painters/workers
- No effect of weather
- Attractive and pleasing appearance
- No cracks on drying
- Produce uniform film

32.4 Types of paints

32.4.1 Oil paint

It is oil based ordinary paint which is applied on wood, plywood, metal surfaces walls etc. It is necessary to apply oil primer before the application of two coats of oil paint. The surface to be painted should be free from moisture before the application of primer coat. These paints are available in glossy and mat finish variety to select as per the requirement. It can be applied with brush/spray painting or roller painting.

32.4.2 Plastic paint

It is water base color which is commonly used for painting walls, ceilings, etc. It can be diluted with water. It is commonly applied with brush or roller. It is necessary to prepare the surface form the application of plastic paint. A primer coat of cement paint is applied on the surface and then wall putty is filled to make the surface smooth. The surface to be painted should be clean and rubbed with sandpaper/water paper to get very smooth surface. Subsequently, two coats of plastic paints are applied on the surfaces to be painted. Thousands of color sheds can be prepared by addition of coloring agents in these paints. Color suppliers have computerized system to add metered amount of coloring agents in the base of the color. Hence, there is a wide range of color sheds to select for the requirement. When the paint dries, film of binders, pigments and other solid is left on the surface. These paints are generally available in thick consistency and water is required to be added for uniform application on the surfaces. After drying of paint, surface can be washed.

32.4.3 Aluminum Paint

It consists of very finely ground aluminum suspended in a medium composed of a quick drying spirit varnish or slow drying oil varnish, according to the requirement. It protects iron and steel from corrosion far better than any other paint. It is widely used for painting marine pillars (supports), oil storage tanks, gas tanks, etc. It also resists heat to a certain extent, so it is applied to radiators, hot water pipes. It is also good for decorative purpose.

32.4.4 Anticorrosive paint

This paint consists of oil and strong drier with chromium oxide or lead or zinc chrome as pigment.

32.4.5 Emulsion paint

It contains binding material such as polyvinyl, synthetic resins etc. This paint is easy to apply and it dries within 2 hours. The surface of the paint is tough and it can be cleaned by washing with water. It is advisable to make the surface smooth before application of paint. A primary coat of cement paint is applied followed by two coats of emulsion paint.

32.4.5 Enamel paint

This paint is available in different colors. It contains white lead or zinc white, oil, spirit and resins. It dries slowly and forms hard durable surface which is not affected by acids, alkalis, fumes, etc.

32.5 Varnishes

It consists of resins dissolved in volatiles. It is made by dissolving the heated resins in hot oils and adding turpentine. Varnishes are available as transparent or translucent. The oil oxidizes to form a tough protective film. Depending on the solvent used, varnishes are classified as under.

- Oil varnishes
- Spirit varnishes
- Turpentine varnishes
- water varnishes

Linseed oil is used as solvent in oil varnishes while methylated spirit is used as solvent in spirit varnishes. Spirit varnishes dry quickly but it is not durable. It is used for furniture. In water varnishes, shellac is dissolved in hot water and required quantity of either ammonia or borax or potash or sods is added so that shellac is dissolved. Varnishes are applied by using smooth fine brush.

32.6 Painting for mold prevention

It is necessary to carry out painting on building and equipment by adopting recommended procedure in order to make the surface which is not suitable for mold growth. It is desirable to use paint containing a fungicide. The fungicide should be such that it is effective, non toxic, impart no odor or flavor to food products and be economical. Solubilized copper quinolinolate has been found to be an effective fungicide for paints, especially when combined with the paint during the manufacturing process. The surfaces containing mold growth may be

treated with a hypochlorite solution containing 0.5 to 1.0% chlorine to prevent a general contamination of the area during the cleaning process. Many patented mold inhibitors are available to use as per the recommendation.

32.7 Painting Problems/ Failures:

The basic reasons for the defects in painting are due to (i) atmospheric conditions (ii) defective surfaces and (iii) Incorrect painting methods.

1. **Alligatoring:** It occurs due to application of relatively fast drying coat over one which is too soft. The reasons for soft under coat could be use of too much oil, use of unsuitable oil which dries to a soft film or due to insufficient drying time before another coat is applied.
2. **Blistering and peeling:** Blistering and peeling is caused by moisture penetration behind the film of paint on the wooden surface and plaster. The change in temperature causes vaporization of moisture which increases the volume. This causes a blister. This may also happen if the seasoning of wood is not done properly.
3. **Cracking and scaling:** This happens when paint becomes too brittle as it ages and then it begins to break. The wood expands and contracts due to moisture absorption which may break the film of color. However, in the long run, the elasticity of the paint decreases. In order to overcome this, more elastic paints of higher grade should be used. In order to repaint the surface, first the old paint should be removed. This can be done by scrapping, using a sand paper or a wire brush, blow torch and scrapper or by using chemical solvents. (liquid paint removal).
4. **Running and sagging:** Use of too much oil results in sagging down and applying too much thick coat also results in sagging. Application of paint to very glossy a surface would also result in sagging. It is necessary to maintain proper viscosity and surface finish of the surface to be painted.
5. **Wrinkling:** Formation of wrinkles is due to improper drying of paints applied on the surface. This happens when surface dries quickly leaving undried paint below.

***** 😊 *****

This Book Download From e-course of ICAR
VISIT FOR OTHER AGRICULTURE BOOKS, NEWS,
RECRUITMENT, INFORMATION, AND EVENTS AT
WWW.AGRIMOON.COM

Give FeedBack & Suggestion at info@agrimoon.com

DISCLAIMER:

The information on this website does not warrant or assume any legal liability or responsibility for the accuracy, completeness or usefulness of the courseware contents.

The contents are provided free for noncommercial purpose such as teaching, training, research, extension and self learning.

***** 😊 *****